

KODAK PIXPRO AZ527

DIGITAL CAMERA

User Manual



Before You Start

Declaration of Conformity

Responsible Party: JK Imaging Ltd.

Address: JK Imaging Ltd., 17239 So. Main Street, Gardena, CA 90248 USA
JK Imaging Europe, 71 Clarendon Road, Watford, WD17 1DS, UK

Company Website: kodakpixpro.com

INDUSTRY CANADA

This device complies with Canadian ISED.

This device complies with ISED's licence-exempt RSSs. Operation is subject to the following two conditions: (1) This device may not cause harmful interference, and (2) this device must accept any interference received, including interference that may cause undesired operation.

Le présent appareil est conforme aux CNR d'ISED applicables aux appareils radio exempts de licence. L'exploitation est autorisée aux deux conditions suivantes : (1) le dispositif ne doit pas produire de brouillage préjudiciable, et (2) ce dispositif doit accepter tout brouillage reçu, y compris un brouillage susceptible de provoquer un fonctionnement indésirable.

Radiation Exposure Statement:

The product comply with the Canada portable RF exposure limit set forth for an uncontrolled environment and are safe for intended operation as described in this manual. The further RF exposure reduction can be achieved if the product can be kept as far as possible from the user body or set the device to lower output power if such function is available.

Déclaration d'exposition aux radiations: Le produit est conforme aux limites d'exposition pour les appareils portables RF pour les Etats-Unis et le Canada établies pour un environnement non contrôlé.

Le produit est sûr pour un fonctionnement tel que décrit dans ce manuel. La réduction aux expositions RF peut être augmentée si l'appareil peut être conservé aussi loin que possible du corps de l'utilisateur ou que le dispositif est réglé sur la puissance de sortie la plus faible si une telle fonction est disponible.

For Customers in Europe



This symbol [crossed-out wheel bin WEEE Annex IV] indicates separate collection of electrical waste and electronic equipment in the European countries. Please do not throw the equipment into domestic refuse. Please use the return and collection systems available in your country for proper, safe disposal of this product.



Batteries: Please dispose of used batteries at designated collection centers.



Packaging: Please follow local regulations for the recycling of packaging.



“CE” mark indicates that this product complies with the European requirements for safety, health, environment and customer protection. “CE” marked cameras are intended for sales in Europe.

Europe – EU Declaration of Conformity

This device complies with the essential requirements of the R&TTE Directive 2014/53/EU. The following test methods have been applied in order to prove presumption of conformity with the essential requirements of the R&TTE Directive 2014/53/EU:

The frequency and maximum transmitted power in EU are listed as below:

2412MHz-2472MHz (Wi-Fi 2.4GHz) : 19.98dBm

- EN 60950-1/A12:2011+A2:2013

Safety of Information Technology Equipment

- EN 50566: 2013

Product standard to demonstrate compliance of radio frequency fields from handheld and body- mounted wireless communication devices used by the general public (30 MHz — 6 GHz)

- EN 62209-2: 2010

Human exposure to radio frequency fields from handheld and bodymounted wireless communication devices — Human models, instrumentation, and procedures

Part 2: Procedure to determine the specific absorption rate (SAR) for wireless communication devices used in close proximity to the human body (frequency range of 30 MHz to 6 GHz)

- EN 300 328 V2.1.1 (2016-11)

Wideband transmission systems; Data transmission equipment operating in the 2,4 GHz ISM band and using wide band modulation techniques

- Draft EN 301 489-1 V2.2.0 (2017-03)

Electromagnetic compatibility and Radio Spectrum Matters (ERM); Electro Magnetic Compatibility (EMC) standard for radio equipment and services; Part 1: Common technical requirements

- Draft EN 301 489-17 V3.2.0 2017

ElectroMagnetic Compatibility (EMC) standard for radio equipment and services; Part 17: Specific conditions for Broadband Data Transmission Systems.

Manufacturer: Sintai Optical (Shenzhen) Co., Ltd

Address: Qiwei Ind Sec, 1st, 2nd, & 3RD Bldg, Lisonglang Village, Gongming Town, Bao'an District, Shenzhen, Guangdong, China

For Customers in the U.S.A.

Federal Communication Commission Interference Statement

This device complies with Part 15 of the FCC Rules. Operation is subject to the following two conditions: (1) This device may not cause harmful interference, and (2) this device must accept any interference received, including interference that may cause undesired operation.

This equipment has been tested and found to comply with the limits for a Class B digital device, pursuant to Part 15 of the FCC Rules. These limits are designed to provide reasonable protection against harmful interference in a residential installation. This equipment generates, uses and can radiate radio frequency energy and, if not installed and used in accordance with the instructions, may cause harmful interference to radio communications. However, there is no guarantee that interference will not occur in a particular installation. If this equipment does cause harmful interference to radio or television reception, which can be determined by turning the equipment off and on, the user is encouraged to try to correct the interference by one of the following measures:

- Reorient or relocate the receiving antenna.
- Increase the separation between the equipment and receiver.
- Connect the equipment into an outlet on a circuit different from that to which the receiver is connected.
- Consult the dealer or an experienced radio/TV technician for help.

FCC Caution: Any changes or modifications not expressly approved by the party responsible for compliance could void the user's authority to operate this equipment.

This transmitter must not be co-located or operating in conjunction with any other antenna or transmitter.

Radiation Exposure Statement:

This product complies with the FCC portable RF exposure limit set forth for an uncontrolled environment and is safe for intended operation as described in this manual. Additional RF exposure reduction can be achieved if the product can be kept as far as possible from the user body or set the device to lower output power if such function is available.

About this Manual

Thank you for purchasing the KODAK PIXPRO Digital Camera. Please carefully read this manual and keep it well for future reference.

- JK Imaging Ltd. reserves all rights of this document. No part of this published manual may be reproduced, transmitted, transcribed, stored in a retrieval system or translated into any language or computer language, in any form, by any means, without the prior written permission of JK Imaging Ltd..
- All trademarks mentioned in this manual are used for identification purposes only and are properties of their respective owners.
- This manual provides you with instructions on how to use your new KODAK PIXPRO Digital Camera. Every effort has been made to ensure that the contents of this manual are accurate; however JK Imaging Ltd. reserves the right to make changes without notice.
- Throughout this manual, the following symbols are used to help you locate information quickly and easily:



Indicates useful information.

- In the instructions below, the following symbols may be used throughout this manual on how to operate the camera. This is to facilitate better understanding:
[Item properties] : The optional properties in the camera interface are indicated by the symbol [] .

Safety Notes

Safety notes for this camera

- Do not drop the camera or allow it to hit solid objects.
- Do not attempt to disassemble or repair the camera.
- Do not use or store the camera in dusty places or on a beach to prevent dust or sand from entering the camera, causing possible damage to it.
- Do not use or store the camera in a hot environment or under direct sunlight.
- Do not use or store the camera near a powerful magnetic field, for example near a magnet or transformer.
- Avoid touching the lens of the camera.
- Do not expose the camera to direct sunlight for a long period time.
- To prevent the camera from being damaged by moisture, do not use or store the camera in very humid environments, such as in rain or near bodies of water.
- If water accidentally comes in contact with the camera. turn the camera off, remove the battery and the memory card, and dry it within 24 hours
- When you take the camera from a cold place to a warmer environment, condensation may occur. Please wait for a reasonable period of time before you turn it on.
- Before you remove the battery and memory card, the camera should be turned off.
- When you clean the body of the camera, don not use abrasive, alcohol-based or organic cleaner.
- Use a professional lens wiping cloth and dedicated cleaner to wipe and clean the lens.
- Download your photos and remove the memory card when you are going to store the camera for a long period of time.
- If this camera is not in use for a long time, please keep it in a dry and clean condition.
- Our company will not pay compensation for any failure of playback of pictures or videos caused by improper operation.

Safety notes for battery

- Please use a battery that is the same type as the one included.
- Please use the attached charger to charge the battery.
- If battery fluid leaks inside the camera, contact our customer service department. If the battery fluid leaks onto your skin, rinse your skin with clean water and seek immediate medical attention.
- Disposal of used batteries should be carried out in accordance with local (national or regional) regulations.
- To prevent the battery from being damaged, do not drop the battery or allow it to hit solid objects or to be scratched by the objects.
- Do not let the battery come in contact with metal objects (including coins) to avoid short circuiting, discharging, excessive heat, or possible leakage.
- Do not attempt to disassemble the battery.
- Do not expose the battery to water. Always keep the battery contacts dry.
- Do not heat the battery or throw it into a fire to avoid a possible explosion.
- Do not store the battery in a hot environment or in direct sunlight.
- If the battery overheats during charging or use, stop charging or use immediately. Turn off the product, remove the battery carefully, and wait until it cools down.
- When the camera is stored for a long period of time, remove the battery and keep it in a dry place that is not accessible to infants and children.
- In a colder environment, the performance of the battery could be noticeably reduced.
- When you install the battery, install it according to the positive and negative markings on the battery compartment. Never force it into the battery compartment.

Safety notes for memory card

- We suggest buying only well-known, name brand memory cards to ensure peak performance.
- Format the memory card using the camera before you use it or insert a new one.
- Do not drop the memory card or allow it to hit solid objects to avoid damaging it.
- Do not attempt to disassemble or repair the memory card.
- Do not expose the memory card to water. Always keep it dry.
- Do not remove the memory card when the camera is turned on. Otherwise, the memory card could be damaged.
- Do not directly edit the data on the memory card. Copy the data to your PC before you edit them.
- When the camera is stored for a long period of time, be sure to download your photos and remove the memory card. Store it in a dry environment.
- Do not modify the name of the files or folders of the memory card using your PC. Modifying the file names may cause the files to not be recognized on the camera or a possible error may occur.
- A photo taken with the camera will be stored in the folder that is automatically generated on the memory card. Do not store photos that are not taken using this camera in these folders as the pictures cannot be recognized during the playback.
- When you insert a memory card, make sure the notch of the card matches the markings on the top of the card slot.

Other Safety Notes

- Do not disconnect the power or turn the camera off during the update process. Doing so may cause incorrect data to be written and the camera may not power on later.
- Do not hang the neck strap of the camera around the neck of a child.
- When using your camera on an airplane, observe the relevant rules specified by the airline.
- Due to the limitations of manufacturing technology, the LCD may have a few dead or bright pixels. These pixels do not affect the quality or performance of the camera, photos or video.
- Do not expose the LCD to water. In a humid environment, only wipe it with a soft and dry cleaning cloth.
- If the LCD screen is damaged, pay particular attention to the liquid crystal in the screen. If any of the following situations arise, take the recommended immediate action indicated below:
 1. If liquid crystal comes in contact with your skin, please wipe with a dry cloth, wash thoroughly with soap, and rinse with plenty of clean water.
 2. If liquid crystal gets into your eye, flush the eye immediately with plenty of clean water for at least 15 minutes and then seek for medical assistance.
 3. If liquid crystal is swallowed, immediately flush your mouth thoroughly with clean water and induce vomiting. Seek for medical assistance.

Contents

Before You Start.....	1
Safety Notes	6
Contents	10
Getting Ready.....	15
Accessories Included.....	15
Install Lens Cap and Neck Strap.....	16
Part Names	17
Installing Battery and Memory Card.....	19
Charging Battery	21
Turning Camera On and Off.....	23
How to take pictures	23
Set your Language, Date/Time	24
Mode Overview	27
Display Setting	27
LCD Display.....	28

Overview of the screen icons in photo shooting mode.....	28
Overview of the screen icons in movie mode	29
Overview of the screen icons in playback mode	30
Using the Mode Dial	31
Select an appropriate capture mode	31
Auto Mode.....	32
Program AE	34
Shutter priority.....	34
Aperture priority	34
Manual Mode.....	34
Face Beautifier	36
Wi-Fi Mode	37
Scene Mode	45
Movie Mode.....	50
Custom Settings	51
Basic Operation	53

Using the Zoom Function.....	53
Focus Setting.....	54
Macro Mode.....	55
Self-timer Setting	56
Flash Mode	57
White Balance Setting.....	58
Continuous Shot	59
EV Setting	60
Using Quick Recording	62
i Button Function Menu.....	63
Playback Mode	64
Viewing Photos and Videos	64
Thumbnail View.....	65
Using Zoom Playback (for still pictures only).....	66
Photos and Video Deletion	67
Slideshow	68
Continuous Capture Group Playback.....	69

Animation panorama play.....	70
Using the Menus.....	71
Photo Setup Menu.....	71
Photo Shooting Settings Menu.....	76
Movie Menu	80
Movie Setting Menu	83
Playback Menu	85
Playback Settings Menu.....	89
Setup Menu	93
Sound Settings.....	94
Power Saver.....	94
Language.....	95
Date/Time.....	95
LCD Brightness.....	95
File Setting.....	96
Format	97

Copy to Card.....	97
File Numbering.....	98
Reset.....	98
FW Version.....	99
Connection Settings	100
Connecting to a Computer.....	101
Connecting to a PictBridge Compatible Printer	103
Using the PictBridge Menu	105
Video System	109
Set Eye-Fi Card Connection Mode	110
Supported HDMI Connections	111
Appendices.....	112
Product Specifications.....	112
Prompts and Warning Messages	116
Troubleshooting	120

Getting Ready

Accessories Included

Your camera box should contain the camera model you purchased along with the following accessories. If anything is missing or appears to be damaged, please contact your retailer. (The battery charger may be different in shape than what is pictured below. This is due to different power requirements across countries or regions)

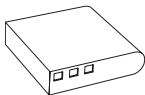

Rechargeable
Li-ion Battery

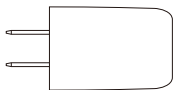

AC Adapter

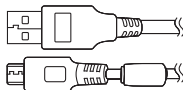

Micro USB Cable

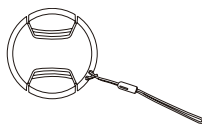

Lens Cap With Cord



Neck Strap



Quick Start Guide



Warranty Card



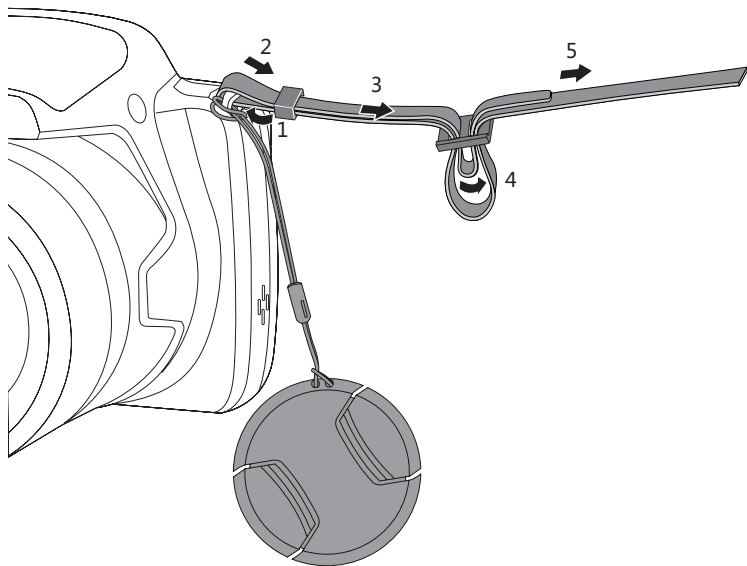

Service Card

Install Lens Cap and Neck Strap



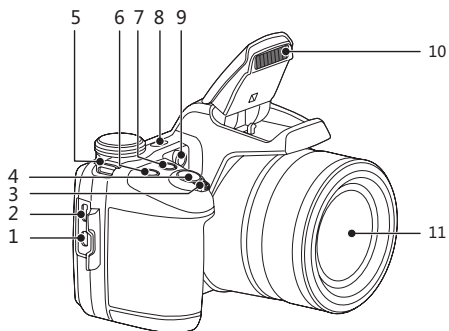





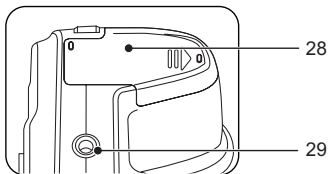
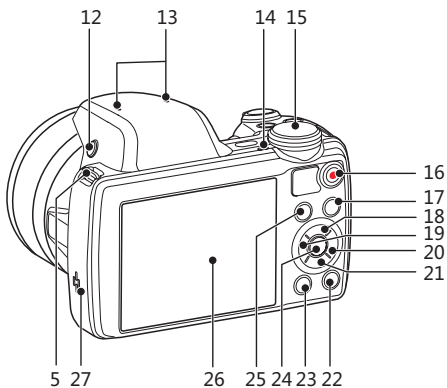



Part Names



1. Micro HDMI Port
2. Micro USB Port
3. Zoom Lever
4. Shutter Button
5. Strap Eyelet
6.  Exposure Compensation Button
7.  Continuous Shot Button
8. Power Button
9. AF Assist Beam/Self-Timer Lamp
10. Flash Lamp
11. Lens



- 12. Flash Button
- 13. Microphone
- 14. Indicator Lamp
- 15. Mode Dial
- 16.  Fast Video Recording Button
- 17.  Menu Button
- 18.  AF Button/Arrow Button (Up)
- 19.  Macro Button/Arrow Button (Left)
- 20.  Flash Button/Arrow Button (Right)
- 21.  Delete Button/Self-Timer Button/Arrow Button (Down)
- 22.  Display Button
- 23.  Playback Button
- 24.  SET Button
- 25.  I Button
- 26. LCD
- 27. Speaker
- 28. Battery Cover
- 29. Tripod Socket

Installing Battery and Memory Card

1. Open the battery cover.

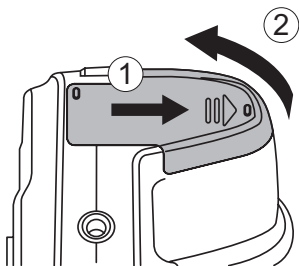

2. Insert the battery into the battery compartment according to the negative and positive directions as illustrated in the picture. Push the battery down until it locks in place.

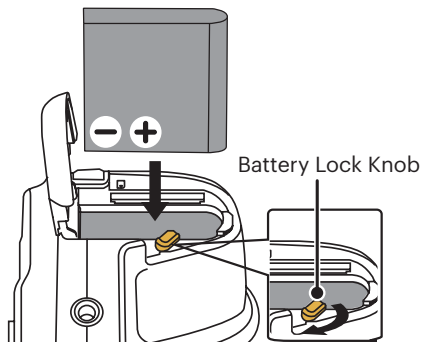

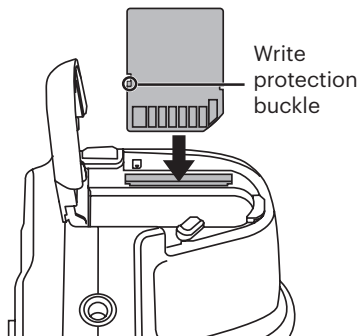

-
3. Insert the memory card into the memory card slot as shown in the diagram below:

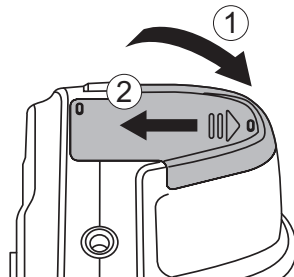

4. Close the battery cover.





-  The memory card (SD/SDHC) is optional and not included in all camera packaging. It needs to be purchased separately. Please use an original memory card which is Class 4 or higher and has a capacity of 4GB to 32GB.
-  To remove your memory card, open the battery cover, gently press the memory card to eject it and remove it carefully.

Charging Battery

Please insert the battery and charge it under shutdown mode.

1. Connect the camera and the power charger using the supplied Micro USB cable.
2. Insert the plug of the power charger into the power outlet to charge the battery.

 After the battery is stored for a long period of time, use the supplied power charger to charge the battery prior to use.

 To have maximum battery life, charge the battery for at least 4 hours the first time.

 Charging indicator:
Steady orange: Charging
The indicator will go out once charging is finished, and the camera will be powered off automatically.

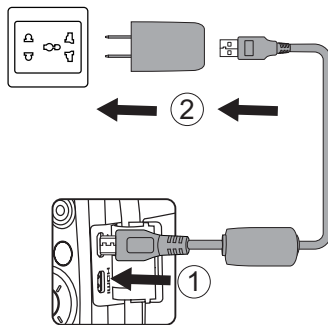

Indicator Lamp

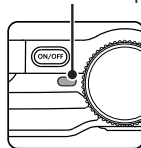

-
3. When the camera is turned off, you can also connect the camera to your PC using a Micro USB cable to charge the battery.

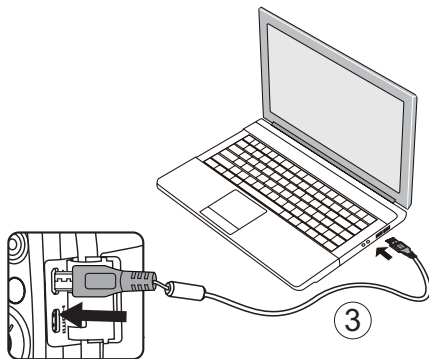

Please charge the battery indoors between 0°C and 40°C.

Turning Camera On and Off

Press the Power button to turn the camera on. To turn the camera off, press the Power button again.

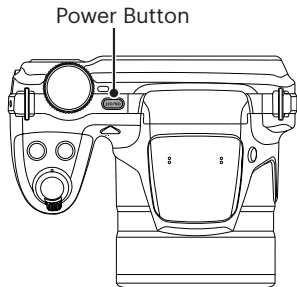

Press and hold the  button to power on and enter Playback mode.

How to take pictures

1. Hold the camera with both hands, not blocking the flash and lens by fingers.
2. Aim the camera at the object and then frame with the LCD.
3. Use the zoom lever to select Tele or Wide positions to zoom in or out on your subject.
4. Press the shutter button half way to focus on the subject. When the focus frame turns green, press the shutter button completely down to take the picture.

Set your Language, Date/Time





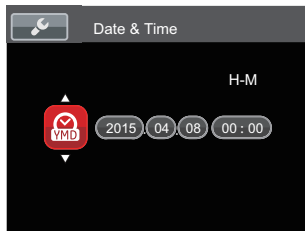











Set your Language, Date/Time after the first power-on

1. When you turn the camera on for the first time, the language selection screen appears.
2. Press the [▲AF] / [▼🗑️🌞] / [◀️🌸] / [▶️🌧️] buttons to select your desired language.
3. After you press the (SET) button to confirm the selection, the Date/Time settings screen appears.
4. Press the [🌸] / [🌧️] button to select the Date/Time to be adjusted: Time is displayed in YYYY.MM.DD HH:MM.
5. Press the [▲AF] / [▼🗑️🌞] button to adjust the value for the selected Date/Time.
6. Press the (SET) button to confirm the time settings and the shooting screen appears.



Resetting your Language





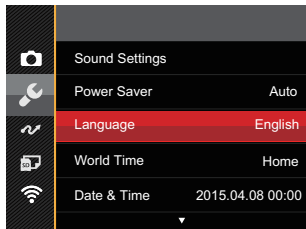















After you set your language for the first time, follow the instructions below to reset your language.

1. Press the  button, press the [**▲AF**] / [**▼**  ] button to select , and press the  button to enter the menu.
2. Press the [**▲AF**] / [**▼**  ] button to select , and press the  / [**▶** ] button to enter the menu.
3. Press the [**▲AF**] / [**▼**  ] button to select [Language] and press the  / [**▶** ] button to enter the menu.
4. Press the [**▲AF**] / [**▼**  ] / [**◀** ] / [**▶** ] buttons to select your desired language and press the  button to confirm.
5. Press the  button and the shooting screen appears.



Resetting Date/Time

After you set your Date/Time for the first time, follow the instructions below to reset date and time.

1. Press the  button, press the [**▲AF**] / [**▼**  ] button to select , and press the  button to enter the menu.
2. Press the [**▲AF**] / [**▼**  ] button to select , and press the  / [**▶** ] button to enter the menu.
3. Press the [**▲AF**] / [**▼**  ] button to select [Date & Time] and press the  / [**▶** ] button to enter the menu.
4. Press the [**◀**  ] button to select the Date/Time to be adjusted: Time is displayed in YYYY.MM.DD HH:MM.
5. Press the [**▲AF**] / [**▼**  ] button to press the value for your selected block. After you finish your settings, press the  button to confirm.
6. Press the  button and the shooting screen appears.

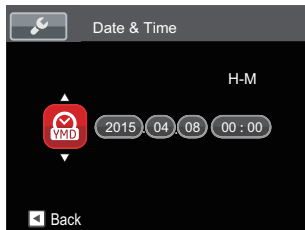
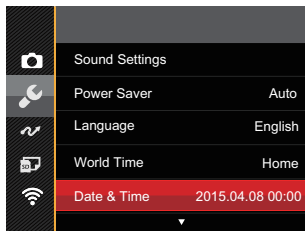

Mode Overview

Display Setting

Press the  button to display the settings: Classic, Full, Off.

Classic: Displays the camera parameters on screen



Off: Does not display any additional icons on screen

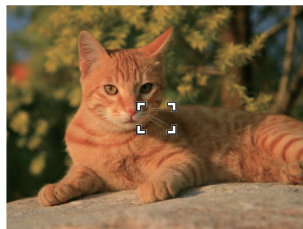

Full: Camera parameters with Grid and Histogram

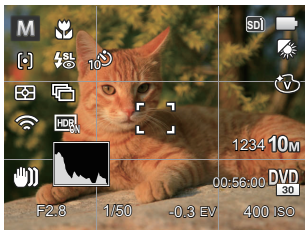

LCD Display

Overview of the screen icons in photo shooting mode

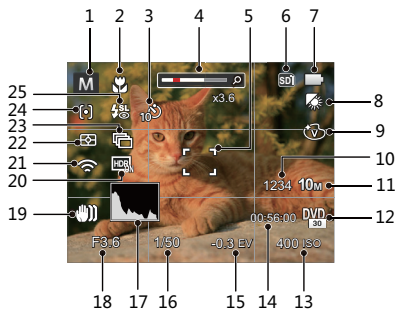

1 Shooting Mode

2 Macro Mode

3 Self-timer

4 Zoom Display (By turning the Zoom Lever)

5 Focus Frame

6 Memory Card/Built-in Memory

7 Battery Status

8 White Balance

9 Color Effect

10 Number of remaining shots

11 Image Size

12 Video Quality

13 ISO Value

14 Remaining Recording Time

15 Exposure Compensation

16 Shutter Speed

17 Histogram

18 Aperture Value

19 OIS (Optical Image Stabilization)

20 HDR

21 Eye-Fi ON (with signal)

22 Expo Metering

23 Continuous Shot

24 AF Mode

25 Flash Mode

Overview of the screen icons in movie mode

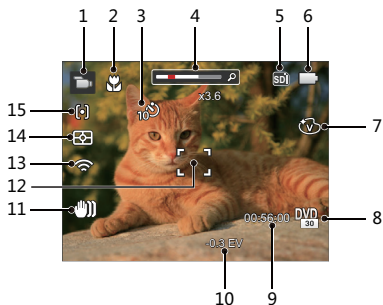

- 1 Movie Mode
- 2 Macro Mode
- 3 Self-timer
- 4 Zoom Display (By turning the Zoom Lever)
- 5 Memory Card/Built-in Memory
- 6 Battery Status

- 7 Color Effect
- 8 Video Quality
- 9 Remaining Recording Time
- 10 Exposure Compensation
- 11 OIS (Optical Image Stabilization)
- 12 Focus Frame
- 13 Eye-Fi ON (with signal)
- 14 Expo Metering
- 15 AF Mode

 For optimal video shooting, it is recommended that an SDHC memory card be used.

 Optical Zoom and Digital Zoom can be adjusted (208X in total). Digital Zoom can be adjusted to 4X.

Overview of the screen icons in playback mode

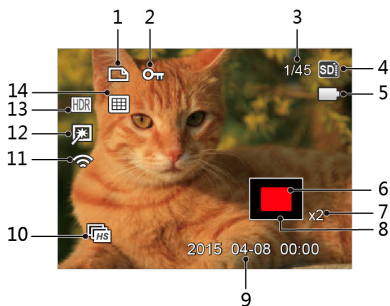

- 1 DPOF File
- 2 File Protection
- 3 Memory Space (indicating the current number of photos and total number of photos)

- 4 Memory Card/Built-in Memory
- 5 Battery Status
- 6 Zoom Magnification Area
- 7 Image Zoom Ratios
- 8 Image Zone
- 9 Shooting Date
- 10 Continuous Capture Group Playback
- 11 Eye-Fi ON (with signal)
- 12 Touch-up
- 13 HDR
- 14 Date Folder

Using the Mode Dial

This camera provides a convenient mode dial that allows you to manually switch among different modes with ease.

Select an appropriate capture mode

1. Press the Power button to turn the camera on. Aim the camera at the object and then frame with the LCD.
2. Rotate the mode dial to select an appropriate shooting mode.



Auto Mode



Manual Mode



Movie Mode



Program AE



Face Beautifier



Custom Settings



Shutter priority



Wi-Fi Mode



Aperture priority



Scene Mode

3. Rotate the zoom lever to zoom in or out of the subjects and compose a photo within the framing scope.
4. Press the Shutter button half way down to focus on the subject. When the focus frame turns green, press the Shutter button completely down to take the picture.

Auto Mode

The camera will automatically detect the most suitable scene to capture the best pictures.



Auto Mode

The camera will automatically adjust the exposure and focus to ensure the best possible pictures.

Landscape Mode

For landscapes, will automatically adjust the exposure and reproduce vivid green and blue colors.

Portrait Mode

Most suitable for capturing people with focus on their faces.

Night Portrait

When you take portraits at night, or in low light conditions, will automatically adjust the exposure for people and night scenes.

Backlit Portrait

When the sun or any other light source is behind you, will automatically adjust the foreground exposure to produce the best pictures possible.

Night Mode

For night scenes, will automatically increase the ISO value to compensate for low light.

Macro Mode

To produce more detailed close-ups, will automatically engage the camera's Macro Mode and automatically focus the lens.

Program AE P

The user can switch the ISO and EV value according to personal preference, the camera can automatically set the shutter speed and aperture value.

Shutter priority S

The user can adjust the shutter speed, EV and ISO values. It is mostly used to shoot the moving object.

Aperture priority A

The user can adjust the aperture size, EV and ISO values. It is generally used to shoot inanimate object and control the view depth.

Manual Mode M





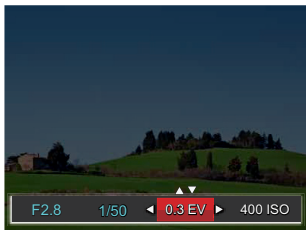

The user can adjust the aperture size, shutter speed and ISO values manually. It is generally used to shoot static photos.

Mode: PSAM

Follow the steps below to adjust the parameters:

1. Rotate the mode dial to select a mode you want, press the  button to configure settings.











2. Press the [] / [] button to select an adjustment item.
3. Press the [AF] / [  ] button to adjust the parameters.
4. Press the  button to confirm the settings and enter the shooting screen.

Items that can be adjusted under **PSAM** mode: (○: Optional x: Not optional, auto display)



Mode \ Items	Aperture value	Shutter speed	EV value	ISO value
P	x	x	○	○
S	x	○	○	○
A	○	x	○	○
M	○	○	x	○

Face Beautifier

The camera is set to automatically adjust camera exposure for realistic portrayal of skin tones.

1. Rotate the mode dial to select .
2. Press the  button and press the [AF] / [ ] button to select .
3. Press the [ ] button to select an option and press the  button to confirm and return to photo shooting mode.



-  Effect 1: Skin Soften
-  Effect 2: Skin Soften+Eye Brightening
-  Effect 3: Skin Soften+Eye Brightening+Eye Enlargement

Wi-Fi Mode

Make image transmission and remote control by connecting smart device with Wi-Fi.

Matters needing attention before use

- Your smart device operating system version needs to be iOS 7 or higher, or Android 4.2 or higher. If not, please upgrade your smart device before using the APP.
- Please do not use in places having high intensity magnetic field, electrostatic and electric wave interference (for example near a microwave oven), which may cause failure in receiving signals.
- To maintain a connection, please keep the camera within 10 meters (32.8 feet) without signal shielding interference.
- Please do not use Wi-Fi connection functionality on a plane.
- The camera and the smart device can only be connected one to one.

Route of downloading the APP package:



Please download APP installation package (APP name: PIXPRO Remote Viewer) to your smart device from the path below and install this application procedure.

■ Android system:



For Android devices, search and download the App “PIXPRO Remote Viewer”  in Google play, and install it following the instructions on the interface.



<https://play.google.com/store/apps/details?id=com.jkimaging.pixproremotewriter>

■ iOS system:



For Apple devices, search and download the App “PIXPRO Remote Viewer”  in App store, and install it following the instructions on the interface.



<https://itunes.apple.com/us/app/pixpro-remote-viewer/id833154167?mt=8>

Refer to the "PIXPRO Remote Viewer User Manual" located on the web:

Americas



<http://kodakpixpro.com/Americas/support/downloads.php>

Europe



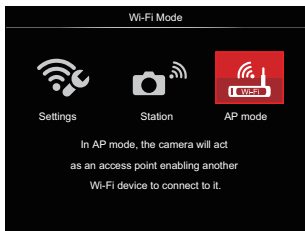

<http://www.kodakpixpro.com/Europe/support/multi-lang-downloads.php>

-
1. Rotate the mode dial to select  and then enter the Wi-Fi selection interface.



2. Press the [] / [] button to select and set options.

-  [Settings] : Customize the Wi-Fi settings for the camera system.
-  [Station] : Use the Station Mode to connect to a "Personal Hotspot" created by your mobile device.
-  [AP mode] : In AP mode, the camera will act as an access point enabling another Wi-Fi device to connect to it.



Rotate the mode dial to disconnect.



AP mode

This camera may connect with your smart device through Wi-Fi.

Settings of Camera:

1. Select  and press the  button to enter the setting interface.

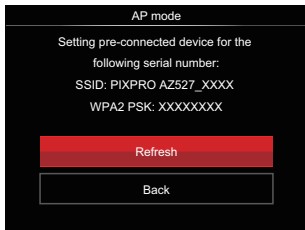

Press the [] / [  ]

- Refresh: Create a new WPA2 PSK password
- Back: Back to previous page

Settings of Smart Device:



2. Enable the Wi-Fi of smart device and then search surrounding wireless devices.
3. Select the name of camera SSID to be connected and then input the eight-digit number password after WPA2 PSK on the camera.
4. Click the icon of the APP  to enable the APP.

Set up completion:

5. Once the APP is connected to the camera, functional operations can be enabled on the smart device.

Station



Enable image transmission and remote control by connecting the camera with a Wi-Fi access point created by your smart device.

1. Enable the Wi-Fi access point of smart device.
2. Select  on camera and then press the  button to confirm connection with smart device.







Press the  /  button to select:

- Scan: Search again surrounding wireless devices.
- : Select the name of device to be connected.
- Back: Back to Wi-Fi mode select screen.

3. Press the  /  button to select the name of smart device to be connected and then press the  button to confirm. Then, the camera enters the password input interface.



Meanings of interface icons:

Icon	Description
	Delete the last letter
	Switch the display of letters in capital and lowercase
	Move the Cursor
	Switch the symbol input
	Input Space

4. Press the [▲AF] / [▼🗑️🔄] / [◀📶] / [▶🔌] buttons to select and then press the (SET) button to confirm your selection. Enter the completion of WPA2 PSK after password storage.
5. Connect immediately after saving.
 - If connected, the LCD will display as shown below:

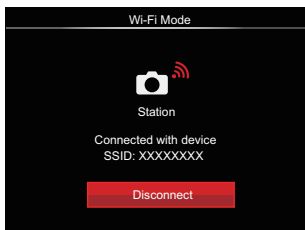

- If connect failed, please check Wi-Fi device and try again.
6. After connection, click the icon of the APP  on the smart device, you may use it to carry out relative operation.

Display of Wi-Fi Connection Status

The Wi-Fi has successfully connected but APP is not enabled:

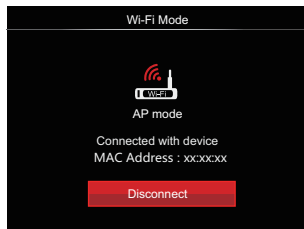

The Wi-Fi has successfully connected and APP is enabled:

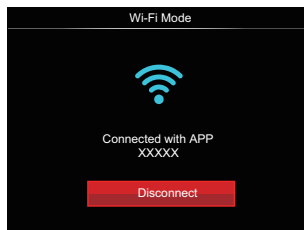

For interrupting the connection:



- No: Keep Wi-Fi connected and back to previous page.
- Yes: Disconnect and back to Wi-Fi mode for interface connection.



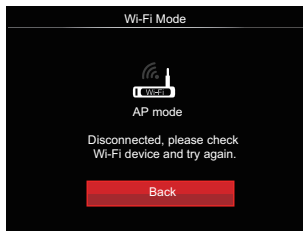



The Wi-Fi of smart device interrupts:





- Back: Back to Wi-Fi mode SSID screen.

Settings

The name of this camera can be changed through key stroking.

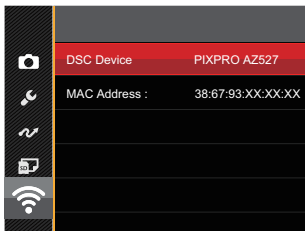
1. Select  and then press the  button to enter the setting interface.
2. Press the [AF] / [] button to select the option to be adjusted and then press the  button to enter the menu.



3. Press the  button to confirm settings and then skip the menu.

DSC Device

The default name of DSC Device is [PIXPRO AZ527]. Change the name of DSC device through key stroking.



For the method of input, please refer to the introduction on password input on Page 41.

MAC Address

Check the wireless MAC Address of this camera.

Scene Mode SCN

The user can select an appropriate mode from the 13 scene modes according to the type of environment you are shooting. The camera then configures the most appropriate settings automatically.

1. Rotate the mode dial to select **SCN** .
2. Press the [**▲AF**] / [**▼**  ] / [**◀** ] / [**▶** ] buttons to select a scene, and press the  button to confirm.

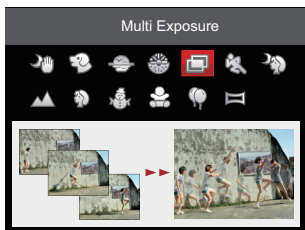

3. If any need of changing the scene, please press the  button and then the  button and finally the [**▲AF**] / [**▼**  ] / [**◀** ] / [**▶** ] buttons to reselect the scene.

Handheld Night

Reduce blur when shooting low light/ illuminated scenes.



Quickly take 4 photos below 8M (including 8M) and then overlap as a clear night image.

Pet Mode

Rapidly identify pet (dog/cat), capture the dynamic moment of pet.



When a cat /dog face is detected, a white focus frame appears. The camera will take a picture and save it regardless of whether the focus is successful (if successful, there appears a green focus frame; if not, there is an orange frame).



At most, 10 dog/cat faces can be detected at one time.

Sunset



For sunsets. Capture subjects in strong sunlight.

Fireworks

For fireworks at night. Suggest using tripod.

Multi Exposure

Suitable for shooting moving objects (as many as 7) in the same background.

-  Keep camera steady before shooting. Press and hold the Shutter button to take 7 photos continuously when it will stop automatically. To stop shooting, release the Shutter button in the midway.
-  Objects shall be moved only from left to the right in order to be recorded. Objects moving from other directions would not be recorded.
-  Shooting effect will be influenced if object is moving too fast or too close.

Sport

For fast-moving subjects. Capture sharp action shots without blur.

Night Portrait

For portraits against night time scenery (Suggest using tripod).

Landscape

Speed adjusted for brilliant images.

Portrait

For shooting portraits

Snow

For subjects in the snow. Reduce underexposure.

Children

For kids and pets. Flash is disabled for eye protection.











Party

For subjects at night without using a tripod. Capture sharp shots without blur.

Panorama Mode

This feature allows you to capture a panoramic view that will have significantly more content than a single photograph. Follow the instruction arrow with a smooth and steady movement of the camera to seamlessly shoot an ultra-wide scene of up to 360 degrees.





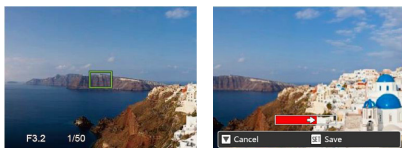

Follow the steps below:

1. Select Panorama Mode (), and then press the  button to confirm.
2. Press the  /    /   /   buttons to select a shooting direction. (The right direction is used as default if you do not make any choice) 2 seconds later, the camera is ready to take pictures. You can also press the  button or half press the Shutter button to be ready to take pictures.

-
3. Compose your shot on the LCD and half press the Shutter button to focus on the subject. After focusing, fully press the Shutter button down to take picture. At this time, the process dialog of panorama mode stitching appears on the screen.





4. Rotate the camera according to the set direction. When the range of rotation does not exceed the range that the camera can detect, the progress dialog along the indication arrow partially turns red. When it completely turns red, panorama mode shooting is finished.

-  Panoramic image can be played back by the method of flash playing. Please see the animation panoramic playback on page 70.
-  During shooting, the flash, self-timer, macro modes and exposure compensation are not available. Focus adjustment is also not available at this time.
-  During panorama mode shooting, press the  button to interrupt shooting and save the current pictures taken. Press the  button to cancel shooting and not to save the previously taken pictures.
-  During panorama mode shooting, when the moving direction of the camera is wrong or the angle deviates from the internal settings, the LCD shows a warning message 「Improper alignment. Please try again.」 and the current pictures taken are saved.

Movie Mode

Switch to this mode to record videos.

Follow the steps below:

1. Rotate the mode dial to select , and it will enter the movie screen.
2. Press the  button or the Shutter button to start recording.



3. Press the  button or the Shutter button again to stop recording, save it automatically and then the camera will return to the movie screen.



In the recording process, you can rotate the zoom lever to zoom in or out of the subject.

Custom Settings CS

The user can store frequently used shooting modes or scene modes with parameters and switch to this mode for quick adjustment.

Settings under CS mode (unset state or state after reset):

1. Rotate the mode dial to select **CS** , and then the camera enters the setting interface as shown below:

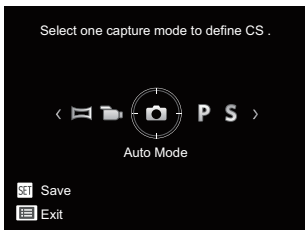

2. As shown in the picture, press the [**⏏**] / [**⏏**] button to select a capture mode that you want to define as **CS** , and press the **(SET)** button to enter the shooting screen.
3. As shown in the picture, press the **(M)** button to confirm setting or to exit without setting by turning the mode dial.

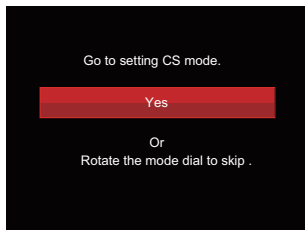

For setting under other modes (use this method to select a different custom setting):

1. Select any mode or scene mode to be stored.
2. Set your desired parameters in the current mode.
3. Press the **(M)** button and then the [**▲AF**] / [**▼**] button to select **(M)** , and press the **(SET)** button to enter the menu.
4. Press the [**▲AF**] / [**▼**] button to select **(M)** , and press the **(SET)** / [**⏏**] button to enter the menu.

5. Press the [▼🗑️🕒] button to select [Custom Settings] and then press the [SET]/[⚡] button to enter the menu

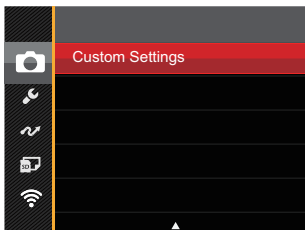

6. Select [Yes] to save or [No] to cancel.

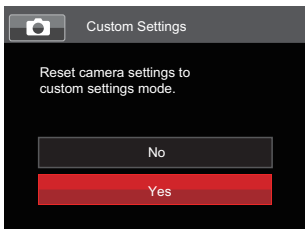

7. Rotate the mode dial to switch to **CS** .
8. The photo settings you stored the last time are invoked.

- When the **CS** mode is used for the first time, there is no preset parameter stored in the **CS** mode.
- If you want to remove the parameter setting of [Custom Settings] , please utilize the reset function as described on page 98.

Basic Operation

Using the Zoom Function

Your camera is equipped with two types of zoom functions: optical zoom and digital zoom. Toggle the zoom lever of the camera to zoom in or out of the subject while taking pictures.

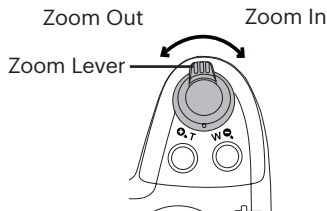

When the optical zoom reaches the threshold as digital zoom, release and turn the zoom lever to T to switch between the optical zoom and digital zoom.

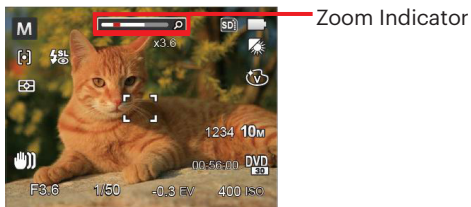

Focus Setting

This function can be adjusted in **PSAM** mode, please follow the steps below to configure the settings:

1. Press the [▲AF] button to enter the Focus menu.



2. Press the [◀🌸] / [▶⚡] button to select the following 3 modes:



- [C] Single-AF
The focus frame appears on the center of the LCD to focus on the subject.
- [FOOD] Multi-AF
The camera automatically focuses the subject in a wide area to find the focus point.
- [D] Object Tracking
Smart tracking of the object in motion under the focusing shooting.

3. Press the [SET] button to confirm the settings and enter the shooting screen.

 Once enabled, Object Tracking will only work when lens is focused on the object.

Macro Mode



The Macro Setting is ideal for shooting small objects or close-up photos. This mode allows you to focus on subjects very close to the camera.

It can be adjusted in **PSAM**   mode, please follow the steps below to configure the settings:

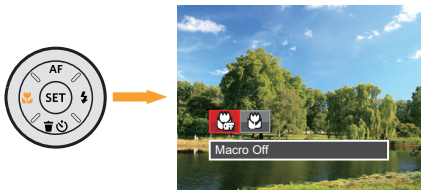
1. Press the [] button to enter the Macro menu.



2. Press the [] / [] button to select the following 2 modes:

-  Macro Off
Select this option to disable Macro.
-  Macro On
Select this option to make focusing on the object closer to the lens (At the W side, the shooting distance should be more than 1 cm).

3. Press the  button to confirm the settings and enter the shooting screen.



Self-timer Setting

Using this function can take photos at regular time. The camera can be set to shoot after 2 seconds, 10 seconds since pressing the Shutter button or shoot after smile.

It can be adjusted in **PSAM** mode, please follow the steps below to configure the settings:

1. Press the [▼🗑️😊] button to enter the Self-timer menu.



2. Press the [😊🗑️] / [▶️⚡] button to select the following 4 modes:
 -  Self-timer Off
Disables the Self-timer.
 -  Self-timer 2 sec
A single picture is shot 2 seconds after the shutter button is pressed.
 -  Self-timer 10 sec
A single picture is shot 10 seconds after the shutter button is pressed.

-  Self-timer Smile
Press the shutter button and a picture will be taken immediately after a smile is detected.

3. Press the (SET) button to confirm the settings and enter the shooting screen.

-  When enabling the self-timer, pressing the shutter button or the [▼🗑️😊] button can disable the self-timer and return to the shooting screen while keeping the self-timer setting.

-  When enabling the smile detection, pressing the shutter button or the (SET) button can disable the self-timer and return to the shooting screen without keeping the self-timer Smile setting.

Flash Mode

The flash provides supplemental light for the scene. The flash is usually used when shooting against the light to highlight the object; it is also suitable for metering and shooting in darker scenes to improve the exposure.

It can be adjusted in **PSAM** mode, please follow the steps below to configure the settings:

1. Press the Flash Button  to pop up the flash.

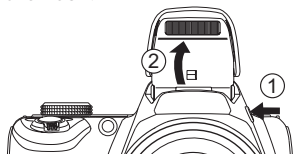



2. Press the  button to enter the Flash menu.





3. Press the  /  button to select the following 6 modes:

-  Force Off
Flash is turned off.

-  Flash Auto
Camera flash goes off automatically based on existing light conditions.

-  Fill Flash
The flash will engage with each shot even if there is enough available light to take the photo without flash.

-  Slow Sync.
This allows you to take pictures of people at night that clearly show both your subjects and the night time backdrop. The use of a tripod is recommended when shooting with this setting.

-  Slow Sync. + Red-Eye
Use this mode for slow synchro shots with red-eye reduction.

-  Red-Eye Reduction
The camera emits a brief pre-flash before the picture is taken to reduce red-eye effects.

4. Press the  button to confirm the settings and enter the shooting screen.

White Balance Setting

The white balance function allows adjustment of the color temperature for different light sources.

It can be adjusted in **PSAM** mode, please follow the steps below to configure the settings:

1. Press **SET** button to enter the White Balance menu.



2. Press the [**☘**] / [**⚡**] button to select the following 8 modes:

- **AUTO WB** AWB
- Daylight
- Cloudy

- Fluorescent
- Fluorescent CWF
- Incandescent
- Manual WB
(Fully press the Shutter button to detect the white balance value)
- Color Temp. (1900K-10000K)
Press the [**▲AF**] / [**▼☘☺**] button to "Adjust the K value";
Press the [**☘**] button to exit the K value.

3. Press the **SET** button to confirm the settings and enter the shooting screen.



Continuous Shot

This function can be adjusted in **PSAM** mode, please follow the steps below to configure the settings:

1. Press the  button to enter the Continuous Shot menu.





2. Press the [] / [] button to select the following 5 modes:

-  Single
Capture a single shot only.
-  Continuous Shot
Take several pictures at a time.

-  Cont. Shot-High Speed (VGA)
For continuous shot with VGA pixel.

-  Cont. Shot-Fast (2M)
For continuous shot with 2M pixels.

-  Time-Lapse
Take pictures based on the preset interval (30sec/ 1min/ 5min/ 10min).

3. Press the  button to confirm the settings and enter the shooting screen.







4. Press the Shutter button to start continuous shooting.

-  In Continuous Shot mode, the flash is automatically set to Force Off in order to achieve quick succession of shots.



EV Setting

The EV function menu of the camera includes functions, such as EV adjustment, ISO adjustment, Shutter adjustment, Aperture adjustment, etc. Using the appropriate function settings can improve your pictures.

Please follow the steps below to configure the settings:

1. Press the  button to display the settings screen.
2. Press the [] / [] button to select the setting options.
3. Press the [AF] / [] button to adjust the option values.
4. Press the  button to confirm the settings and enter the shooting screen.

Exposure Compensation

Set up to adjust the picture brightness. In the case of a very high contrast between the photographed object and the background, the brightness of the picture can be appropriately adjusted. (Adjustable in **PSA**   Mode)

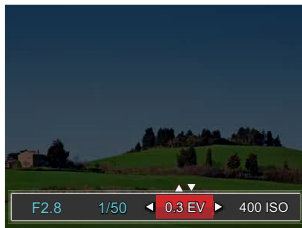

The adjustable range of exposure value is from EV -3.0 to EV+3.0.

ISO

ISO allows you to set the sensitivity of the camera sensor. Please use a higher ISO value in darker places and a lower value in brighter conditions. (Adjustable in **PSA M** Mode).

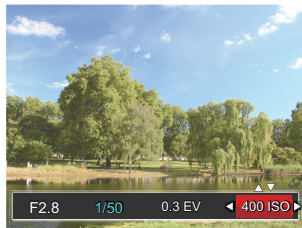

The camera's ISO settings include: Auto, 100, 200, 400, 800, 1600 and 3200.

Shutter Adjustment

For shutter speed, the camera may automatically set the aperture value corresponding to the manually set shutter speed so as to obtain a most suitable exposure value. The movement of object may be shown by adjusting the shutter speed. High shutter value will allow you to clearly capture the movement of fast moving objects while a low shutter value will allow you to take a picture of a fast moving object while showing a strong sense of movement. (Adjustable in **SM** Mode).

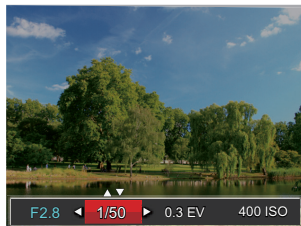

Aperture Adjustment

You can adjust the aperture size value. Selecting a large aperture opening will emphasize the point of focus and show a blurry background and foreground. A small aperture opening will keep both the background and main object in clear focus. (Adjustable in **AM** Mode)



Using Quick Recording

In shooting mode, press the  button to begin recording video.

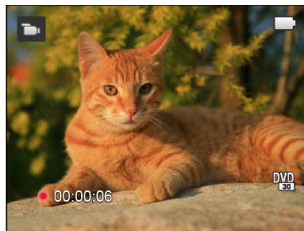

After recording, press the  button or the shutter button to stop recording. The camera will store the video and return to the shooting screen.



i Button Function Menu

The Image Color Setting allows you to select different color effects.



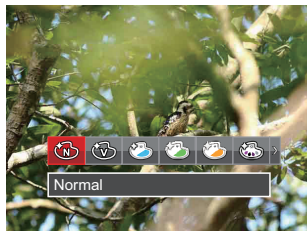

























It can be adjusted in **PSAM** mode, please follow the steps below to configure the settings:

1. Press the **i** button to select the Image Color Setting Menu.
2. Press the **[◀🌸] / [▶⚡]** button to select the Image Color Setting options.



 () represents optional in Movie mode.





There are 20 Image Color options in photo shooting mode **PSAM** :

 Normal ()	 Sepia ()	 Vignetting
 Vivid ()	 Partial Color-Red ()	 Salon
 Japan Style	 Partial Color-Blue ()	 Fish Eye (20M Not optional)
 Italian Style	 Partial Color-Yellow ()	 Reflection
 French Style	 Partial Color-Green ()	 4 Grids - Stylish (2M)
 Punk	 Negative	 Sketch
 Black and White ()	 Dreamy	

Playback Mode

Viewing Photos and Videos

To view photos and videos on the LCD:

1. After pressing the  button, the last photo or video clip taken will be displayed on the LCD.
2. Use the [] / [] button to scroll through the photos or video clips stored in the internal memory or on the memory card.
3. To play a selected video clip, press the  button to enter the movie playback mode. During video playback, the operating instructions will appear on the screen. Press the appropriate buttons to enable the corresponding functions.

Under Playback

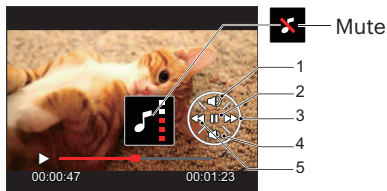

1	Increase volume
2	Pause
3	Fast forward
4	Decrease volume
5	Rewind

Paused

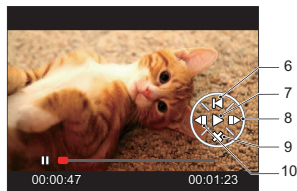

6	Back to the beginning of the video
7	Play
8	Play video forward
9	Cancel playback
10	Play video backward



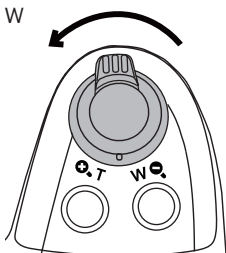

Thumbnail View

When in playback mode, rotate the zoom lever counter to the **W**  position to display thumbnail images of the photos and videos on the screen.

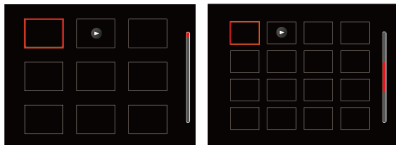

1. Slide the zoom lever to switch between 3 x 3 and 4 x 4 thumbnails.







2. Press the [**▲**AF] / [**▼**  ] / [**◀** ] / [**▶** ] buttons to select a picture or video clip to view and press the **SET** button to restore it to the original size.







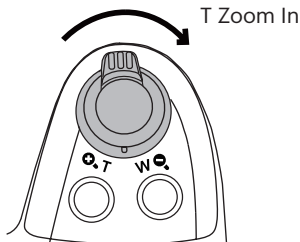

When the icon  appears, it means this is a video file.

Using Zoom Playback (for still pictures only)

When playing back photos, you can also use the Zoom Lever to zoom in on the photos 2 to 8 times.

1. Press the  button to switch to playback mode.
2. Press the  /  button to select a picture to be zoomed in.
3. Rotate the zoom lever clockwise to  T to zoom in.



4. The screen will display the number of times and area of the photo zooming operation.
5. Press the  /  /  /  /  buttons to navigate and select a part of the image to be zoomed in.
6. Press the  button to return the image to its original scale.



Movie images cannot be magnified.

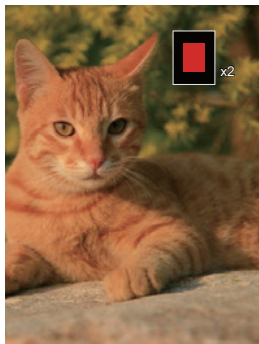
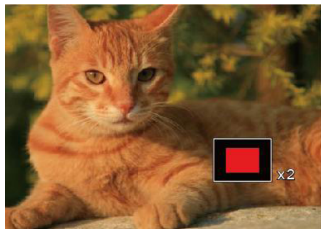

Photos and Video Deletion

In playback mode, press the [▼🗑️🕒] button to delete your photos and videos.

To delete photos or videos:

1. Press the [▶] button to switch to playback mode.
2. Press the [◀🌸] / [▶⚡] button to select the photos and videos to be deleted.
3. Press the [▼🗑️🕒] button and the deletion screen is displayed.

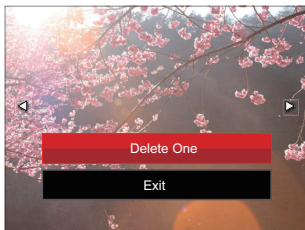

4. Press the [▲AF] / [▼🗑️🕒] button to select [Delete One] or [Exit] and press the [SET] button to confirm.







Erased photos/video clips cannot be recovered.







Please refer to page 91 for instructions on deleting more than one image at a time.

Slideshow

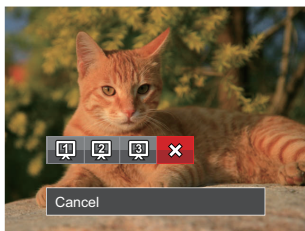
This setting allows you to view all the stored images as a slideshow.





1. Press the  button to enter playback screen.
2. Press the  button to enter slide option.
3. Press the  /  button to select slideshow playing or [Cancel] to return to the playback screen.



4. Press the  button to confirm the setting.
 -  The continuous capture group playback may be displayed by slideshow.
 -  Pictures rotate automatically during a slide show.
 -  Slide playing function supports movie playing.

Continuous Capture Group Playback



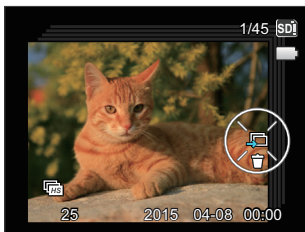

Cont.Shot-High Speed (VGA) and Cont.Shot-Fast (2M) can make continuous capture for group image playback.

1. Press  button to enter playback screen.
2. Press the [] / [] button to select cont. group.
3. Press  to start playback.







Animation panorama play

Panoramic animation playing is to play full size image in accordance with the shooting direction. After playing, it will automatically return to the static screen of panoramic image.

1. Press the  button to enter playback screen.
2. Press the [] / [] button to select animated panoramic photos.
3. Press the  button to play in selected shooting direction.











 In the process of panoramic animation playback, press the [  ] button () to stop playing and return to the playback screen.

Using the Menus

Photo Setup Menu

Functions that can be enabled are different under each mode.

Mode: **PSAM** + **SCNS**



1. In photo shooting mode, press the  button to enter the shooting menu.
2. Press the [**▲AF**] / [**▼**  ] button to select the item to be set.
3. Press the [**◀**  ] / [**▶**  ] button to select an option and press the  button to confirm.

Refer to the following pages for more details about each setting.

Expo Metering

Use this setting to select the “target” size of the camera’s field of view to be metered.



-  AiAE (Artificial Intelligence AE): Automatically selects the central and peripheral metering, to calculate the reasonable value of metering by weighting.
-  Spot: For metering targets a small area in the center of the camera’s field of view.
-  Center: For metering targets a slightly larger area in the center of the cameras field of view.

 It can be adjusted in all modes except for Panorama Mode.

Image Size

The size setting refers to the image resolution in pixels. A higher image resolution allows you to print that image in larger sizes without degrading the image quality.



- **20M** Size: High quality printing
- **18M** Size: Full size printing
- **15M** Size: 16:9 display
- **10M** Size: Poster printing

- **5M** Size: A3 printing
- **3M** Size: A4 printing
- **2M** Size: 4"x 6" printing
- **VGA** Size: E-Mail

 The larger the number of recorded pixels, the larger the file size and the fewer files that can be saved on your memory card.

OIS (Optical Image Stabilization)

This mode can help reduce photo blur caused by unintentional hand shake, low light.

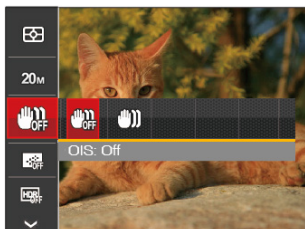

-  OIS: Off
-  OIS: On



 Use this image stabilization mode in dark environments.

 Shooting in a windy or unstable environment (such as a moving vehicle) may cause blurred images.

Cont. AF

Enable the continuous AF to be able to continuously focus automatically when taking pictures.



-  Cont.AF: Off
-  Cont.AF: On

HDR

Use this setting to control wide dynamic image range when taking static pictures. Photos with extreme contrast of bright and dark areas will still maintain distinguishable detail and depth. (Suggest using tripod)







-  HDR: Off
-  HDR: On

 In the scenario with high light contrast (too dark or too light), this function can be used to shoot satisfactory photos.

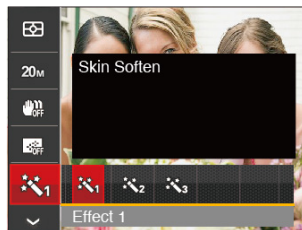
Beautifier

Set the effect of the face beautifier mode.



-  Effect 1: Skin Soften
-  Effect 2: Skin Soften+Eye Brightening
-  Effect 3: Skin Soften+Eye Brightening +Eye Enlargement

Scene

Select the scene mode under the SCN mode.

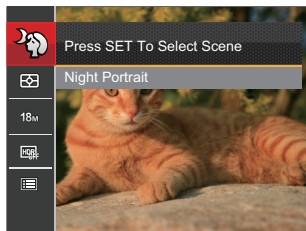







Shooting menu in the Photo shooting mode
(○: Optional X: Not optional)









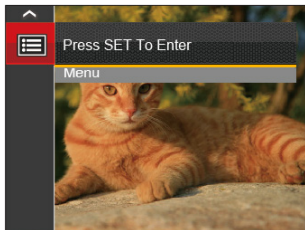











Options	Photo Shooting Modes					
		P	S	A	M	
	○	○	○	○	○	○
20M	○	○	○	○	○	○
	X	○	○	○	○	○
	X	○	○	○	○	○
	X	○	○	○	○	X
	X	X	X	X	X	○

Photo Shooting Settings Menu

Mode:  P S A M +  SCN CS

1. Press the  button in Photo Shooting mode and press the [AF] / [] button to select  .



2. Press the  button to enter the menu.
3. Press the [AF] / [] button to select  , and press the  / [] button to enter the menu.
4. Press the [AF] / [] button to select the item to be set and press the  / [] button to enter the menu.
5. Press the [AF] / [] button to select an option and press the  button to confirm.

Quality

The Quality Setting can be used to adjust the image compression ratio.

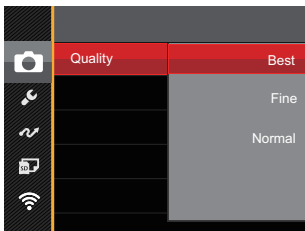

- Best
- Fine
- Normal

AF Assist Beam

In a darker environment, AF Assist Beam can be turned on for better focus.

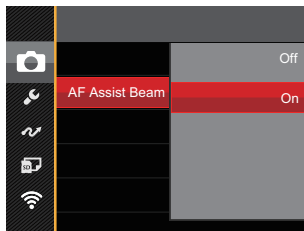

Digital Zoom

This setting is for adjusting digital zoom. If this function is disabled, only optical zoom can be used.

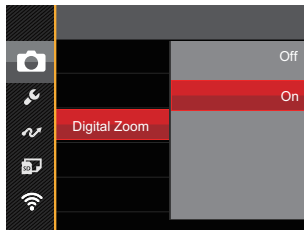

Date Imprint

Include a Date/Time stamp on the photo image.

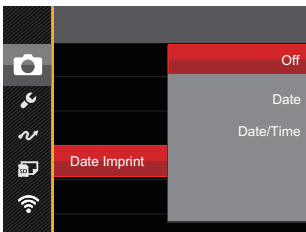

- Off
- Date
- Date/Time

Quick Review

This option allows quick review of the photos immediately after they are taken. Each photo is displayed on the LCD based on the selected time.

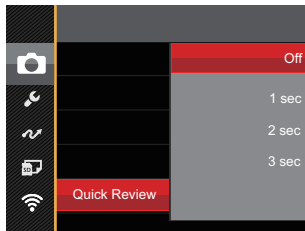

- Off
- 1 sec
- 2 sec
- 3 sec

Custom Settings

Custom Settings stores the current photo shooting mode or scene mode and its parameters. The stored mode and parameters are directly invoked in **CS** mode.

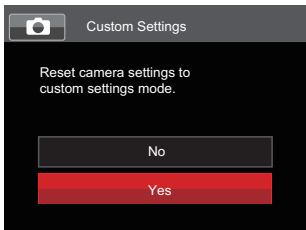

There are 2 options:





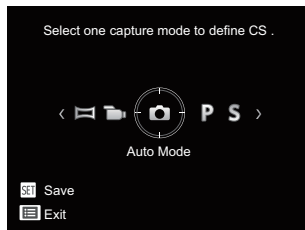





- No
- Yes

 In **CS** mode, select [Custom Settings] the camera will enter the setting interface as shown below:



Movie Menu



Mode: 

1. Rotate the mode dial to select , and press the  button to enter the movie menu.
2. Press the [AF] / [  ] button to select the movie menu to be set.
3. Press the [ ] / [ ] button to select an option and press the  button to confirm.

Expo Metering

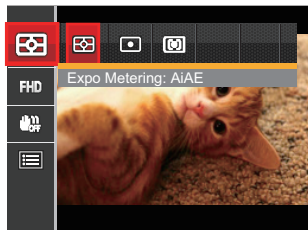
Use this setting to select the “target” size of the camera’s field of view to be metered.



-  AiAE (Artificial Intelligence AE)
Automatically selects the central and peripheral metering, to calculate the reasonable value of metering by weighting.
-  Spot
For metering targets a small area in the center of the camera’s field of view.
-  Center
For metering targets a slightly larger area in the center of the cameras field of view.

Movie Size

Set the image resolution used during video recording.

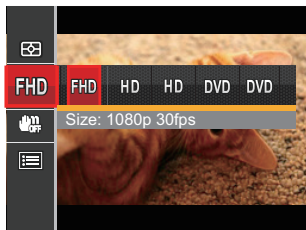

- **FHD** Size: 1080p 30fps
- **HD** Size: 720p 60fps
- **HD** Size: 720p 30fps
- **DVD** Size: 640x480 30fps
- **DVD** Size: 640x360 120fps
(High Speed Movie)

The speed requirements for reading and writing high image pixel images to memory card are as follows:

No.	Image Pixel	Frame	Recommendation	Recording time (4GB) About
1	1920x1080 *	30	Class 4	30 minutes
2	1280x720 *	60	Class 4	32 minutes
3	1280x720 *	30	Class 4	59 minutes
4	640x480	30	Class 4	106 minutes
5	640x360	120	Class 4	54 minutes



* The longest recording time is 29 minutes at one time.

When recording in higher pixel resolutions for extended periods of time, this can cause the camera to generate heat. This is not a camera malfunction.

When the video format is set as 640x360 (120fps), shooting time is 30 seconds, playback time is 2 minutes.

Sound recording is disabled when 640x360 120fps is chosen.

OIS (Optical Image Stabilization)

This mode can help reduce images blur caused by unintentional hand shake, low light.

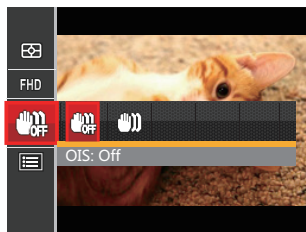







-  OIS: Off
-  OIS: On

Use this image stabilization mode in dark environments.









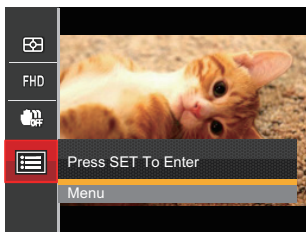

Shooting in a windy or unstable environment (such as a moving vehicle) may cause blurred images.

Movie Setting Menu

Mode: 

1. Rotate the Mode Dial and select , to enter the video recording screen.
2. Press the  button, press the [**▲AF**] / [**▼**  ] button to select , and press the  button to enter the menu.



3. Press the [**▲AF**] / [**▼**  ] button to select , and press the  / [**▶** ] button to enter the menu.
4. Select the item to be set and press the  / [**▶** ] button to enter the menu.
5. Press the [**▲AF**] / [**▼**  ] button to select an option and press the  button to confirm.

Digital Zoom

This setting is for adjusting digital zoom. If this function is disabled, only optical zoom can be used.

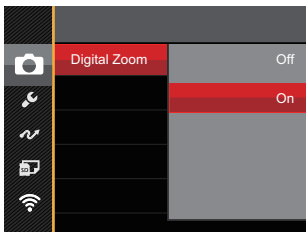





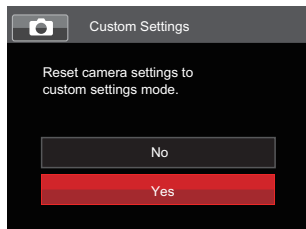





Custom Settings

Custom Settings stores the current movie mode and its parameters. The stored mode and parameters can be invoked directly in **CS** mode.



Playback Menu

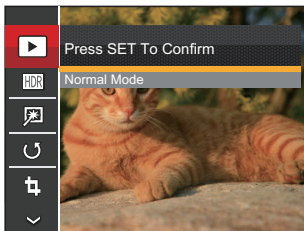

Mode: 

1. Press the  button to display the playback screen and press the  button to enter the menu.
2. Press the [AF] / [  ] button to select the item to be set and press the  button to enter.
3. Press the [ ] / [] button to select an option and press the  button to confirm.





Refer to the following pages for more details about each setting.

Playback Mode

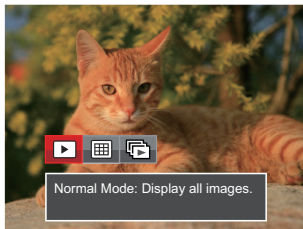
Select , and press the  button to enter the settings screen:



-  Normal Mode:
Display all images.
-  Date Mode:
Arranged by date.
-  Cont. Photo Mode:
Arranged by Cont. Photo Group.



The Date Folder is displayed in date order based on camera's Date/Time Settings.



If there is no continuous shot image file in memory, continuous shot playback mode cannot be enabled.

HDR

With the HDR function, pictures that are overexposed may be corrected to optimize the highlights and lowlights captured to more accurately represent the actual scene.

Select **HDR**, and press the **SET** button to enter the settings screen:



- HDR
- Cancel

After using the HDR function, the image will be saved as a new file and the original file is still stored in the memory.

Touch-up

The playback beauty feature allows for beautification using three individual effects.

Select , and press the **SET** button to enter the settings screen:

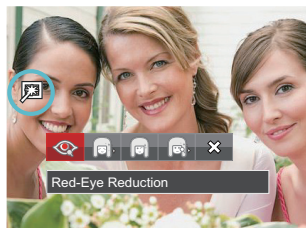



- Red-Eye Reduction
- Skin Soften
- Eye Brightening
- Eye Enlargement
- Cancel

Using the face beautifier mode allows you to select from single, two, or all three effects combined.

Rotate

You can use this setting to change the orientation of the picture.

Select , and press the  button to enter the settings screen:

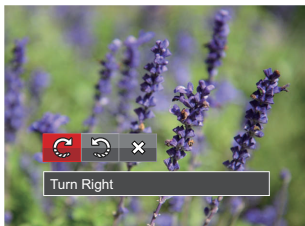



-  Turn Right
-  Turn Left
-  Cancel

 Videos and panoramic pictures cannot be rotated.



 The rotated picture file will replace the original photo.

Resize

This setting allows you to resize a picture to a particular resolution and saves it as a new picture.

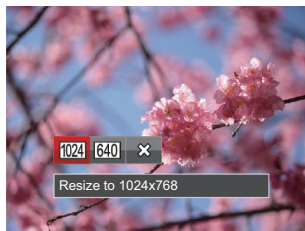
Select , and press the  button to enter the settings screen:



-  Resize to 1024x768
-  Resize to 640x480
-  Cancel

 Only for adjusting pictures with high resolution to those with low resolution.

 Sizes of photos taken in panorama mode or rotated cannot be adjusted.







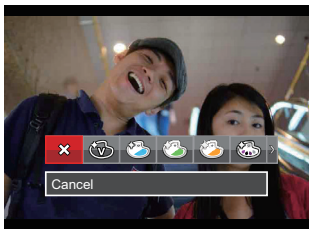











Color Effect

This setting allows you to change the picture color effect. The file is saved as a new photo and stored in memory together with the original photo.

Press the  button to enter the settings screen:

















There are 19 options available:









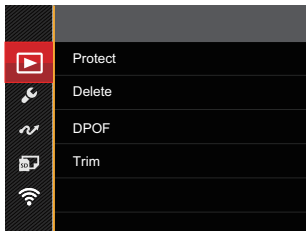

 Cancel	 Sepia	 Vignetting
 Vivid	 Partial Color-Red	 Salon
 Japan Style (8M)	 Partial Color-Blue	 Fish Eye (20M Not optional)
 Italian Style (8M)	 Partial Color-Yellow	 Reflection
 French Style (8M)	 Partial Color-Green	 4 Grids - Stylish(2M)
 Punk (4M)	 Negative (8M)	
 Black and White	 Dreamy	

Playback Settings Menu

Mode: ▶

1. Press the  button to show the playback screen, press the  button, press the [**▲AF**] / [  ] button to select  , and press the  button to enter the menu.
2. Press the [**▲AF**] / [  ] button to select  , and press the  / [ ] button to enter the menu.



3. Press the [**▲AF**] / [  ] button to select the item to be set and press the  / [ ] button to enter the menu.
4. Press the [**▲AF**] / [  ] button to select an option and press the  button to confirm.

Refer to the following pages for more details about each setting.

Protect

To prevent any pictures or videos from being accidentally erased, use this setting to lock one or all of the files.

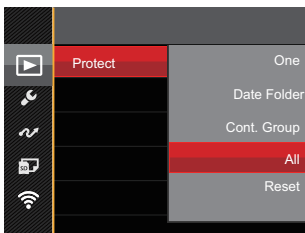

There are 5 options available:

- One: Lock the selected photo or video if they are unprotected; unlock the selected photo or video if they are protected.
- Date Folder: Protect all photos in the date folder.
- Cont. Group: Protect all photos in the cont. photo folder.
- All: Lock all photos or videos.
- Reset: Cancel all locked photos or videos.

Delete

You can delete one or all photo/video files.

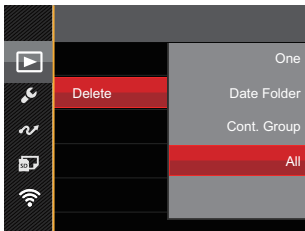

There are 4 options available:

- One: Delete one photo or video.
- Date Folder: Delete all photos in the date folder.
- Cont. Group: Delete all photos in the cont. photo folder.
- All: Delete all photos or videos.



The “🔒” indicator means a file is protected. File protection must be removed first before a file can be deleted.



Deleting files will cause DPOF settings to be reset.



When one photo in the cont. photo and date folders is protected, it will be kept but any other photos will be deleted.

DPOF (Digital Print Order Format)

The DPOF feature allows you to compile and select a group of pictures that you would like to print and will save your selection on the memory card so that you can use the memory card to print without having to individually specify the photos you want to print.

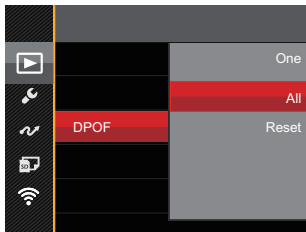

The printer that supports DPOF is needed for printing.

Trim

The Trim Setting allows you to crop photos and save them as new pictures.

1. Select [Yes] to confirm trim. Rotate the zoom lever to select the aspect ratio and press the [▲AF] / [▼AF] / [☺] / [☹] / [▶] / [◀] buttons to adjust the part you want to trim.

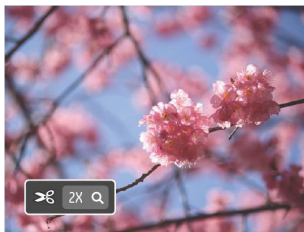

2. Press the **SET** button and the [Save Change?] prompt appears. Select [✓] to change and save the picture. Select [✗] to cancel changes and return to the trim prompt screen.



The image cannot be clipped/trimmed again once it has been clipped to 640X480.

Setup Menu

Mode: PSAM SCN CS

1. Press the button in any mode, press the [AF]/[] button to select , and press the button to enter the menu.
2. Press the [AF]/[] button to select , and press the /[] button to enter the menu.

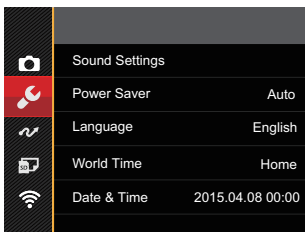

3. Press the [AF]/[] button to select the item to be set and press the /[] button to enter the menu.
4. Press the [AF]/[] button to select an option and press the button to confirm.

Refer to the following pages for more details about each setting.

Sound Settings

With this setting you may adjust the sound volume.

Press the [◀🔊] / [▶🔊] button to adjust the volume and press the (SET) button to confirm our setting.

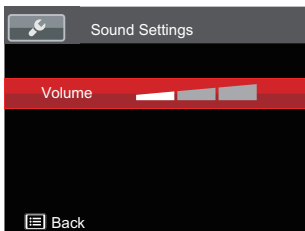

Power Saver

This setting allows you to save power and get the maximum possible running time for your camera's batteries. Turn the LCD and camera off automatically after a consecutive period of inactivity.

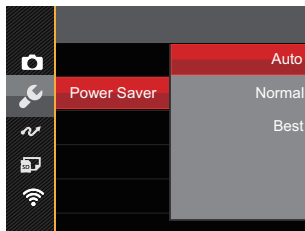

- Auto
- Normal
- Best









Power Saver	LCD power off time	Turn off time
Auto	3 min	5 min
Normal	1 min	3 min
Best	30 s	1 min

Language

Refer to the “Reset your language” section on page 25.

World Time

The world time setting is a useful function for your overseas trips. This feature enables you to display the local time on the LCD while you are abroad.

1. Press the [**▲AF**] / [**▼**   ] button to select the departure place () and destination () fields.
2. Press the [**▲**  ] / [**▶** ] button to select a city located in the same time zone as that of the field. Press the  button to confirm settings.





Date/Time

Refer to the “Reset Date/Time” section on page 26.

LCD Brightness

Use this setting to adjust the brightness of your LCD.

Press the [**▲AF**] / [**▼**  ] button to adjust the brightness of screen, and press the  button to confirm our setting.

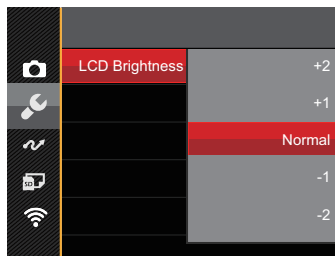

File Setting

Mode: PSAM SCN CS

1. Press the button, press the [AF] / [] button to select and press the button to enter the menu.
2. Press the [AF] / [] button to select and press the / [] button to enter the menu.
3. Press the [AF] / [] button to select the item to be set and press the / [] button to enter the menu.

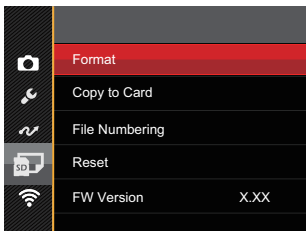



4. Press the [AF] / [] button to select an option and press the button to confirm.

Refer to the following pages for more details about each setting.

Format

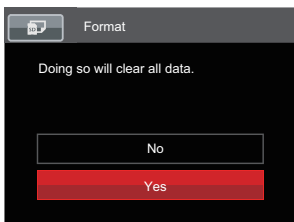
Please note: formatting enables you to delete all contents in the memory card and built-in memory, including protected photo and movie files.



-  If you select [Yes] the camera formats its memory.
-  If there is no memory card in the camera, the built-in memory will be formatted; if there is a memory card, it will be formatted only.

Copy to Card

Use this setting to copy the files stored in the built-in memory to a memory card.

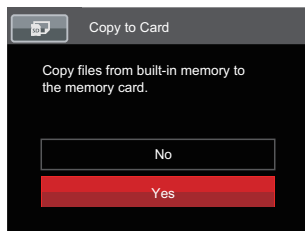

-  If there is no card available in the camera, this function will not be displayed.

File Numbering

After you take a picture or video clip, the camera will save it with a sequential number. You can use this to reset the file numbering to 0001.

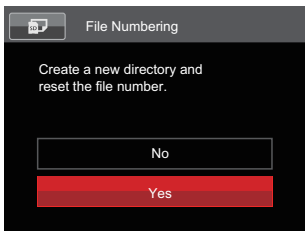

Reset

Use this setting to restore the camera to its original default settings.

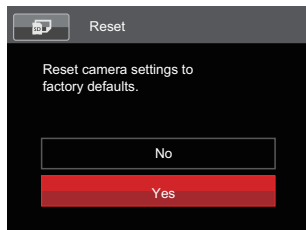

FW Version

Use this setting to view the current camera firmware version.

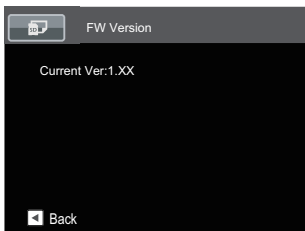

When there is a new firmware version in the memory card, select [Yes] to update.

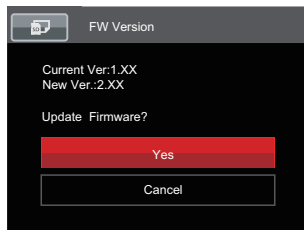

Connection Settings

Mode: PS AM SCN CS

1. Press the button, press the [] / [] button to select and press the button to enter the menu.
2. Press the [] / [] button to select and press the / [] button to enter the menu.
3. Press the [] / [] button to select the item to be set and press the / [] button to enter the menu.

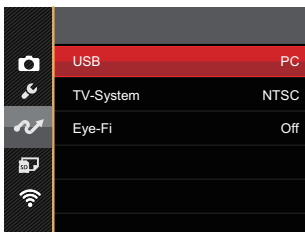

4. Press the [] / [] button to select an option and press the button to confirm.

Refer to the following pages for more details about each setting.

Connecting to a Computer

You can use the Micro USB cable to connect the camera and copy (transmit) photos to a computer, printer or other device.

Setting the USB Mode

The camera's USB port can be set to connect with either a computer or a printer. The following steps will allow you to ensure that the camera is correctly configured to connect with a PC.

1. Press the [▲AF] / [▼🗑️🔄] button to select [USB] and press the (SET) / [▶⚡] button to enter the menu.
2. Press the [▲AF] / [▼🗑️🔄] button to select [PC] and press the (SET) button to confirm.

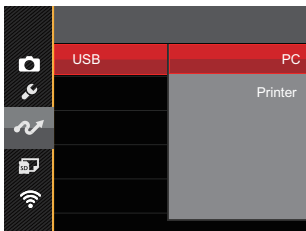

Transferring files to your computer

The computer will automatically detect the camera as a removable drive. Double-click the My Computer icon on the desktop to locate the removable drive and to copy folders and files in the drive to a directory on your PC as you would copy any typical folder or file.

Follow the steps below to connect the camera to a computer.

1. Make sure the computer is turned on.
2. Connect one end of the supplied Micro USB cable to the USB port on your camera.
3. Connect the other end of the Micro USB cable to an available USB port on your computer.

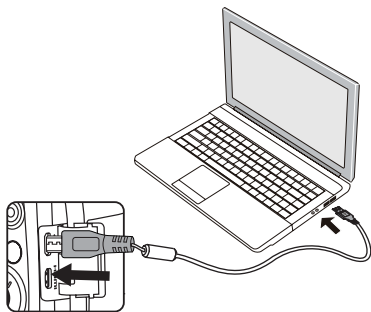

4. After the transmission is complete, disconnect the Micro USB cable according to the instructions specifying how to safely remove USB devices.

Connecting to a PictBridge Compatible Printer

PictBridge technology allows printing of the photos saved in the memory card by the printer.

To find out if a printer is PictBridge compatible, simply look for the PictBridge logo on the packaging or check the owner's manual for specifications. With the PictBridge function on your camera, you can print the captured photos directly to a PictBridge compatible printer using the supplied Micro USB cable, without the need for a PC.

Setting the USB Mode

The camera's USB port can be set to connect with either a PC or a Printer; the following steps will ensure that the camera is correctly configured to connect with a Printer.

1. Press the [▲AF] / [▼🗑️🔄] button to select [USB] and press the (SET) / [▶⚡] button to enter the menu.
2. Press the [▲AF] / [▼🗑️🔄] button to select [Printer] and press the (SET) button to confirm.

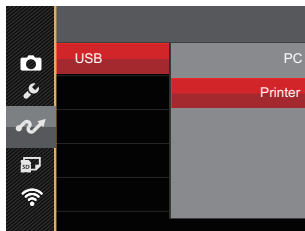

- ① After the camera is reset, it will switch to PC mode automatically from USB mode.
- ① See “Using the PictBridge Menu” section on page 105.

Connecting to your Printer

1. Make sure the printer is turned on.
2. Connect one end of the supplied Micro USB cable to the USB port on your camera.
3. Connect the other end of the Micro USB cable to the USB port on the printer.

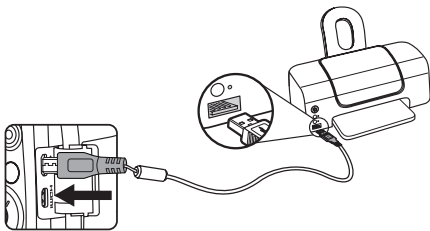

If the camera is not connected to a PictBridge compatible printer, the following error message will appear on the LCD.



The error message above will also appear if the USB mode is set incorrectly, in which case you should disconnect the Micro USB cable, check the USB mode settings, ensure that the printer is turned on, and then try connecting the Micro USB cable again.

Using the PictBridge Menu

After setting the USB mode to Printer, the PictBridge menu will appear.

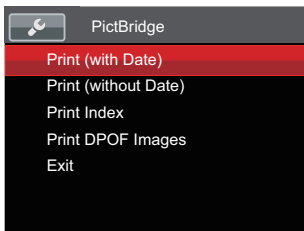

Press the [▲AF] / [▼🗑️🔄] button to select a menu item and press the (SET) / [▶⚡] button to enter the item.

Refer to the following sections for more detailed information on each setting.

Print (with Date)

If you have set the date and time on your camera, the date and time will be recorded and saved with each photo you take.

1. In the PictBridge menu, select [Print (with Date)] and the screen as shown below appears.

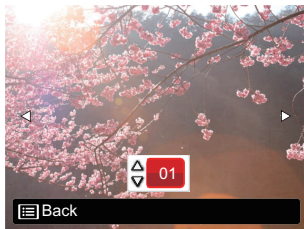

2. Press the [◀🌸] / [▶⚡] button to select a photo to be printed.

3. Press the [▲AF] / [▼🗑️🕒] button to select the number of copies for the currently displayed photo.
4. Press the (SET) button and the following screen will appear.

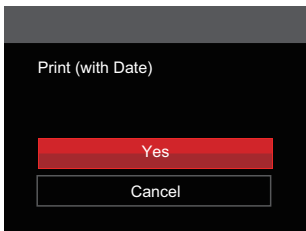

5. Select [Yes] and press the (SET) button to confirm printing; select [Cancel] and press the (SET) button to cancel printing.

Print (without Date)

Use this setting to print the photos without dates on them.

1. In the PictBridge menu, select [Print (without Date)] and the screen as shown below appears.

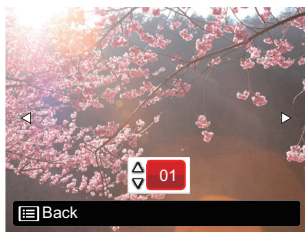

2. Press the [◀🌸] / [▶⚡] button to select a photo to be printed.
3. Press the [▲AF] / [▼🗑️🕒] button to select the number of copies for the currently displayed photo.

-
4. Press the **SET** button and the following screen will appear.

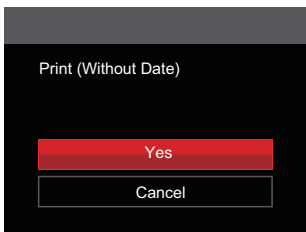

5. Select [Yes] and press the **SET** button to confirm printing; select [Cancel] and press the **SET** button to cancel printing.

Print Index

You can print all photos in the camera via this function.

1. In the PictBridge menu, select [Print Index] and the screen as shown below appears.

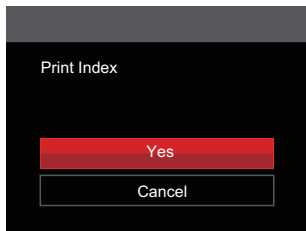



2. Select [Yes] and press the **SET** button to confirm printing; select [Cancel] and press the **SET** button to cancel printing.

Print DPOF Images

To use DPOF printing, you must select your photos for printing using the DPOF settings beforehand. See “DPOF” section on page 92.

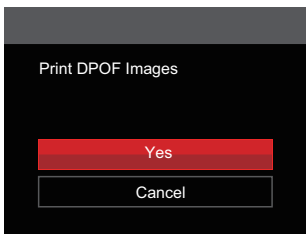
1. In the PictBridge menu, select [Print DPOF Images] and the screen as shown below appears.



2. Select [Yes] and press the  button to confirm printing; select [Cancel] and press the  button to cancel printing.

Exit

Select [Exit] to exit the PictBridge menu. At this time, the message [Remove USB Cable!] appears on the screen.

Disconnect the Micro USB cable from the camera and printer.

Video System

You can use the AV cable (which should be purchased separately) to connect the camera and the television for realizing the video output. Connect one end of the AV cable to USB/AV port of the camera; connect the other end to AV-OUT port of the television. Adjust the format of the video output system according to your requirements, and the steps are as follows:

1. Press the [▲AF] / [▼🗑️🔄] button to select [TV-System] and press the (SET) / [▶⚡] button to enter the menu.
2. Press the [▲AF] / [▼🗑️🔄] button to select [NTSC] , and press the (SET) button to confirm.

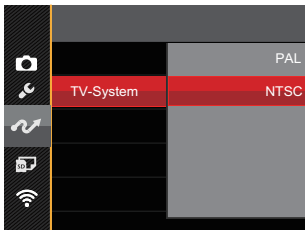

The video output system would change accordingly based upon the changes of the selected language.

NTSC: English, Chinese (Traditional), Japanese, French, Korean, Russian, Vietnamese, Greek, Hungarian

PAL: German, Spanish, Italian, Chinese (Simplified), Portuguese, Swedish, Danish, Finnish, Indonesia, Norwegian, Dutch, Turkish, Polish, Thai, Croatian, Czech, Arabic, Hindi

Set Eye-Fi Card Connection Mode

This camera supports the wireless connection for Eye-Fi memory card, Enable Eye-Fi connection by following below steps.

1. Press the [▲AF] / [▼🗑️🔄] button to select [Eye-Fi] and press the (SET) / [▶️🔌] button to enter the menu.
2. Press the [▲AF] / [▼🗑️🔄] button to select [On] or [Off] and press the (SET) button to confirm.

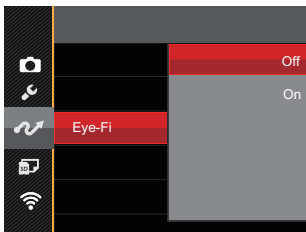



If the Eye-Fi card is not available in the camera, this feature is not displayed.

Supported HDMI Connections

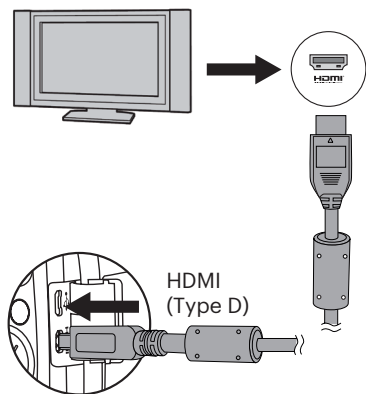
HDMI (High Definition Multimedia Interface) is a fully digital audio/video transmission interface, through which uncompressed audio and video signals are transmitted. Direct transmission of digital video signals to your TV reduces conversion loss and improves image quality.



Connecting HDMI-Ready TV

1. Use the cable with high resolution output terminal (which should be purchased separately) to connect the camera to the television which meets HDMI standard.
 2. The camera will be automatically detected by the TV.
 3. After connecting via HDMI, the camera enters Playback Mode.
-  Make sure the camera and the TV are both turned on before connecting.
 -  Refer to your TV instruction manual for information on what resolution sizes it will support. The resolution and output formats that are not supported will be grayed out on the camera's LCD.

Appendices

Product Specifications



Design and specifications are subject to change without notice.

Image Sensor	Type	1/2.3"BSI CMOS
	Effective Pixels	20.68 Megapixels
	Total Pixels	21.14 Megapixels
Lens	Focal Length	4.3mm (Wide) — 223.6mm (Tele)
	35mm film equivalent	24mm (Wide) — 1248mm (Tele)
	F number	F2.8 (Wide) ~ F5.6 (Tele)
	Lens Construction	13 groups 15 elements
	Optical Zoom	52x
	Optical Zoom	Normal: (Wide) 60cm ~ ∞ , (Tele) 300cm ~ ∞ ; Macro: 1cm ~ ∞ (Wide Only)
Autofocus System		TTL Autofocus
Anti-Handshake		Optical Image Stabilization
Digital Zoom		4x Digital Zoom (Combined Zoom: 208x)

Number of Recording Pixels	Still Image	(4:3) 20MP: 5184 X 3888 10MP: 3648 X 2736 5MP: 2592 X 1944 3MP: 2048 X 1536 0.3MP: 640 X 480	(3:2) 18MP: 5184 X 3456	(16:9) 15MP: 5120 X 2880 2MP: 1920 X 1080
	Movie	1920 X 1080 (30fps), 1280 X 720 (60fps/30fps), 640 X 480 (30fps), High-Speed Movie: 640 X 360 (120fps)		
Image Compression		Best, Fine, Normal		
DCF, DPOF (Ver1.1) Support		Yes		
File Format	Still Image	Exif 2.3 (JPEG)		
	Movie	MOV [Image: H.264; Audio: Linear PCM (Stereo)]		
Shooting Modes		Auto Mode, Program AE, Shutter priority, Aperture priority, Manual Mode, Face Beautifier, Wi-Fi Mode, Scene Mode, Movie Mode, Custom Settings		
Scene Mode		Handheld Night, Pet Mode, Sunset, Fireworks, Multi Exposure, Sport, Night Portrait, Landscape, Portrait, Snow, Children, Party, Panorama Mode		
Detection Features		Face, Smile, Blink, Cat, Dog		
Photo Touch-up		Red-Eye Reduction, Skin Soften, Eye Brightening, Eye Enlargement		
HDR		Yes		

Scan Panorama		Up to 360°
LCD		3.0 inch (460k Pixels)
Image Auto Rotation		Yes
ISO Sensitivity		Auto, ISO100/200/400/800/1600/3200
AF Method		Single AF, Multi-AF (TTL 25-point), Object Tracking, Face-Detection
Exposure Metering Method		Artificial Intelligence AE (AiAE), Center-Weighted Average, Spot (Fixed to Center of Frame), Face AE
Exposure Control Method		Program AE (AE-Lock Available), Shutter Prior AE, Aperture Prior AE
Exposure Compensation		±3 EV in 1/3 Step Increments
Shutter Speed		1/2000 ~ 30 Seconds
Continuous Shot		Yes
Playback Modes		Single, Index (9/16 Thumbnails), Slide Show, Date, Continuous Shooting, Zoom (Approx. x2 ~ x8)
White Balance Control		AWB, Daylight, Cloudy, Fluorescent, Fluorescent CWF, Incandescent, Manual WB, Color Temp. (1900K ~ 10000K)
Flash	Flash Method	Pop-up (Manual)
	Flash Modes	Force Off, Flash Auto, Fill Flash, Slow Sync., Slow Sync.+Red-Eye, Red-Eye Reduction

Recording Media	Internal Memory: Approx. 8MB
	SD/SDHC Card (Up to 32GB Support) [MMC Card Not Supported]
Multi-Language Support	27 Languages
Jacks	AV-OUT/USB 2.0 (Micro 5 pin USB), HDMI (Type D)
Eye-Fi Support	Yes
Wi-Fi	Yes (802.11b/g/n)
Remote Viewfinder	Yes (via ios/Android device)
Power	Rechargeable Li-ion Battery LB-060, 3.7V 1100mAh, In-Camera Charging
Shooting Capability (Battery Performance)	Approx. 240 Shots (Based on CIPA Standards)
Operation Environment	Temperature: 0 ~ 40°C, Humidity: 0 ~ 90%
Dimensions (W X H X D)	Approx. 121.3 X 85.8 X 97.5mm (Based on CIPA Standards)
Weight	Approx. 508g (Body only)

Prompts and Warning Messages

Message	Description	Action
Warning! Battery exhausted.	Warning before power off when the camera battery is exhausted.	Charge the battery.
Lens obstruction, Re-start Camera.	The lens is jammed or some foreign object is preventing the lens from functioning properly.	Turn off the camera and restart it to reset the lens.
Suggest using tripod.	The message will appear when shooting in low light/illuminated scenes.	Use of a tripod or other support is suggested.
Built-in memory error!	An error occurs in built-in memory.	Format the internal memory.
Improper alignment. Please try again.	The offset is too big for panorama shooting.	Remove the message after 2 seconds and return to shooting.
Warning! Do not turn off your camera during update!	The message appears during the firmware update process.	The message disappears after the camera update and restart.

Message	Description	Action
Remove USB Cable!	Indicates that you can disconnect the Micro USB cable.	The message disappears after you disconnect the Micro USB cable.
Connection Failed!	Failure to connect to your PC, printer, TV (with HDMI).	Remove the cable and retry connection.
Write Protect !	The memory card is locked.	Unlock the write-protect switch of the memory card.
Card Full !	Indicates that the memory card is full.	Insert a new memory card or delete unwanted images.
Memory Full !	Indicates that the internal memory is full.	Insert a new memory card or delete unwanted images.

Message	Description	Action
Card Error !	The memory card can't be identified after being formatted.	Insert a new memory card or format the card with this camera.
Card is not formatted.	The inserted memory card is unformatted or has been formatted on a computer or other device and is not compatible with this camera.	Disappear after 2 seconds and enter the formatting process.
Slow access	When a memory card lower than Class 4 is used to record a HD movie, the writing speed will be slower and recording will not continue.	Use an memory card with Class 4 or higher.
No Red-Eye Detected!	Red eyes have not been detected in the image.	The message will disappear after 2 seconds.
This image cannot be edited.	The file format does not support editing or the edited file cannot be edited again.	The message will disappear after 2 seconds.

Message	Description	Action
Exceeded maximum folder number.	Prompt message when the archives or file folders in the memory card have reached the maximum (9999 for archives, 999 for file folder).	Copy the images to your PC and format the memory card with this camera.
Too many pictures for fast processing.	During the playback by date, the images exceed specifications so that it is not possible to play by date.	This may be solved by deleting unnecessary images.
Unable to recognize files.	The format of the file to be viewed is not supported or the file is corrupted so it cannot be properly read.	You may be able to play it back on another brand of camera or on your computer.
No Picture!	When you press the play button, no image files exist in the camera or memory card.	The message disappears 2 seconds later to return to the photo shooting screen.
No continuous group file.	When you switch from the playback mode to continuous photo mode, there is no continuous group file.	The message disappears after 2 seconds and the camera returns to the normal playback mode.
Protected! Undeleteable!	The file is protected. The message appears when you delete it.	Unprotect the file before deleting.

Troubleshooting

Problem	Possible Causes	Solution
Camera does not turn on	<ul style="list-style-type: none">■ The battery has been depleted.■ The battery is not inserted correctly.	<ul style="list-style-type: none">■ Recharge the battery.■ Correctly reinstall the battery.
Camera turns off suddenly during operation	<ul style="list-style-type: none">■ The batteries have been depleted.	<ul style="list-style-type: none">■ Recharge the battery.
The picture is blurred	<ul style="list-style-type: none">■ Camera shakes while taking a picture.	<ul style="list-style-type: none">■ Turn on OIS feature.■ Please use tripod for high magnification (above 15X) optical zoom.
Images and video files cannot be saved	<ul style="list-style-type: none">■ The memory card is full.■ The memory card is locked.	<ul style="list-style-type: none">■ Use another memory card or delete unnecessary files.■ Unlock the memory card.
Images will not print from the connected printer	<ul style="list-style-type: none">■ The camera is not connected to the printer correctly.■ The printer is not PictBridge compatible.■ The printer is out of paper or ink.■ The printer paper is jammed.	<ul style="list-style-type: none">■ Check the connection between the camera and printer.■ Use a PictBridge compatible printer.■ Load paper into the printer or replace the ink cartridge in the printer.■ Remove the jammed paper.

Problem	Possible Causes	Solution
Saving data to memory card is slow	<ul style="list-style-type: none"> ■ Using a memory card below Class 4 may result in slower recording times. 	<ul style="list-style-type: none"> ■ Use an memory card with write Class higher than 4 to improve performance.
Cannot write to the memory card	<ul style="list-style-type: none"> ■ The memory card has been locked. 	<ul style="list-style-type: none"> ■ Release the write lock of the memory card or replace with another card.
Too many movies to process	<ul style="list-style-type: none"> ■ The number of pictures or folders in the memory card exceed the specifications, so the playback of data folder cannot be displayed. 	<ul style="list-style-type: none"> ■ Delete unwanted files.
The flash icon  appears on the LCD	<ul style="list-style-type: none"> ■ Current shooting environment requires flash. 	<ul style="list-style-type: none"> ■ Turn on flash.



When shooting with stacked filters attached, the corners of the photo may turn dark (Vignetting effect) because the filter holder blocks light from reaching the camera image sensor; especially, at wide angle zoom control settings. Please take test shots and review the results when using stacked filters.



Please enter the new password on smart device after changing Wi-Fi password. Some models of smart device will remember the Wi-Fi password previously entered, so please clear the old password on smart device manually before connection (For different models, this operation may be varied, please subject to your user manual.)

iOS system

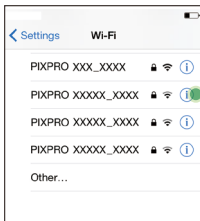

1



2

3

Android system

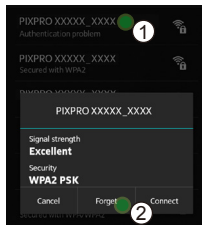

1

2

© 2018 JK Imaging Ltd. All Rights Reserved.

The Kodak trademark, logo and trade dress are used under license from Eastman Kodak Company.

All other logos, products or company names that are referred to in this document are trade names, trademarks or registered trademarks of their holders. The holders are not affiliated with JK Imaging Ltd., our products or our website.

JK Imaging Ltd., 17239 So. Main Street, Gardena, CA 90248 USA

JK Imaging Europe, 71 Clarendon Road, Watford, WD17 1DS, UK

kodakpixpro.com

Made in Myanmar

