

# KODAK PIXPRO AZ528

DIGITAL CAMERA

## User Manual



# BEFORE YOU START

## Declaration of Conformity

Responsible Party: JK Imaging Ltd.  
Address: JK Imaging Ltd., 17239 So. Main Street, Gardena, CA 90248 USA  
Company Website: kodakpixpro.com

## INDUSTRY CANADA

This device complies with Canadian RSS-210.

This device complies with Industry Canada license-exempt RSS standard (s). Operation is subject to the following two conditions: (1) this device may not cause interference, and (2) this device must accept any interference, including interference that may cause undesired operation of the device.

## Radiation Exposure Statement:

This product complies with the Canadian portable RF exposure limit set forth for an uncontrolled environment and is safe for intended operation as described in this manual. Additional RF exposure reduction can be achieved if the product can be kept as far as possible from the user body or set the device to lower output power if such function is available.

## NEW CAMERA OWNER / IMPORTANT INFORMATION

Thank you for purchasing your new **KODAK PIXPRO AZ528 Astro Zoom** camera. In an effort to provide you with the most up to date benefits and features of the AZ528, **we strongly encourage you to register your new camera on our website:**

**<https://kodakpixpro.com/support/product-registration>**

Doing so will keep you informed of important updates, including firmware, features and other important information that pertain to the AZ528. Your information is always kept secure, is encrypted and is never sold, shared or used for any purposes other than for AZ528 camera specific notifications, unless you opt-in to receive other types of communications during the registration process.

## For Customers in Europe



This symbol [crossed-out wheel bin WEEE Annex IV] indicates separate collection of electrical waste and electronic equipment in the European countries. Please do not throw the equipment into domestic refuse. Please use the return and collection systems available in your country for proper, safe disposal of this product.



"CE" mark indicates that this product complies with the European requirements for safety, health, environment and customer protection. "CE" marked cameras are intended for sales in Europe.

Europe – EU Declaration of Conformity

This device complies with the essential requirements of the RED Directive 2014/53/EU. The following test methods have been applied in order to prove presumption of conformity with the essential requirements of the RED Directive 2014/53/EU:

- EN60950-1/A12:2011+A2:2013

Safety of Information Technology Equipment

- EN55032:2015/AC:2016 Class B

- EN61000-3-2:2014

- EN61000-3-3:2013

- EN55035:2017

- EN 62479:2010

Assessment of electronic and electrical equipment related to human exposure restrictions for electromagnetic fields (0 Hz-300 GHz)

- EN 300 328 V2.2.2 (2019-07)

Wideband transmission systems; Data transmission equipment operating in the 2.4 GHz ISM band and using wide band modulation techniques

- EN 301 489-1 V2.1.1 (2017-02)

Electromagnetic compatibility and Radio spectrum Matters (ERM); ElectroMagnetic Compatibility (EMC) standard for radio equipment and services; Part 1: Common technical requirements

- EN 301 489-17 V3.1.1 (2017-02)

Electromagnetic compatibility and Radio spectrum Matters (ERM); ElectroMagnetic Compatibility (EMC) standard for radio equipment; Part 17: Specific conditions for Broadband Data Transmission Systems

### **For SAR statement**

A minimum separation distance of XX cm must be maintained between the user's body and the device, including the antenna during body-worn operation to comply with the RF exposure requirements in Europe.

To compliance with RF Exposure requirements in Europe, third-party belt-clips, holsters or similar accessories used by this device should not contain any metallic components. The use of accessories that do not satisfy these requirements may not comply with RF exposure requirements, and should be avoided.

Hereby, Sintai Optical (Shenzhen) Co., Ltd, declares that this PIXPRO AZ528 is in compliance with the essential requirements and other relevant provisions of Directive 2014/53/EU.

Manufacturer: Sintai Optical (Shenzhen) Co., Ltd

Address: Qiwei Ind Sec, 1st, 2nd, & 3RD Bldg, Lisonglang Village, Gongming Town, Bao'an District, Shenzhen, Guangdong, China



Batteries: Please dispose of used batteries at designated collection centers.



Packaging: Please follow local regulations for the recycling of packaging.

### **For Customers in the U.S.A.**

Federal Communication Commission Interference Statement

This device complies with Part 15 of the FCC Rules. Operation is subject to the following two conditions: (1) This device may not cause harmful interference, and (2) this device must accept any interference received, including interference that may cause undesired operation.



This equipment has been tested and found to comply with the limits for a Class B digital device, pursuant to Part 15 of the FCC Rules. These limits are designed to provide reasonable protection against harmful interference in a residential installation. This equipment generates, uses and can radiate radio frequency energy and, if not installed and used in accordance with the instructions, may cause harmful interference to radio communications. However, there is no guarantee that interference will not occur in a particular installation. If this equipment does cause harmful interference to radio or television reception, which can be determined by turning the equipment off and on, the user is encouraged to try to correct the interference by one of the following measures:

- Reorient or relocate the receiving antenna.
- Increase the separation between the equipment and receiver.
- Connect the equipment into an outlet on a circuit different from that to which the receiver is connected.
- Consult the dealer or an experienced radio/TV technician for help.

FCC Caution: Any changes or modifications not expressly approved by the party responsible for compliance could void the user's authority to operate this equipment.

This transmitter must not be co-located or operating in conjunction with any other antenna or transmitter.

### **Radiation Exposure Statement:**

This product complies with the FCC portable RF exposure limit set forth for an uncontrolled environment and is safe for intended operation as described in this manual. Additional RF exposure reduction can be achieved if the product can be kept as far as possible from the user body or set the device to lower output power if such function is available.

## About this Manual

Thank you for purchasing the KODAK PIXPRO Digital Camera. Please carefully read this manual and keep it well for future reference.

- JK Imaging Ltd. reserves all rights of this document. No part of this published manual may be reproduced, transmitted, transcribed, stored in a retrieval system or translated into any language or computer language, in any form, by any means, without the prior written permission of JK Imaging Ltd.
- All trademarks mentioned in this manual are used for identification purposes only and are properties of their respective owners.
- This manual provides you with instructions on how to use your new KODAK PIXPRO Digital Camera. Every effort has been made to ensure that the contents of this manual are accurate; however JK Imaging Ltd. reserves the right to make changes without notice.
- Throughout this manual, the following symbols are used to help you locate information quickly and easily:



Indicates useful information.

- In introducing you how to operate this camera, the following symbols may appear to facilitate your understanding:  
[Item properties] : The optional properties in the camera interface are indicated by the symbol [ ] .

# SAFETY NOTES

## Safety notes for this camera

- Do not drop the camera or allow it to hit solid objects.
- Do not attempt to disassemble or repair the camera.
- Do not use or store the camera in dusty places or on a beach to prevent dust or sand from entering the camera, causing possible damage.
- Do not use or store the camera in a hot environment or in direct sunlight.
- Do not use or store the camera near a powerful magnetic field, such as a magnet or transformer.
- Avoid touching the lens of the camera.
- Do not expose the camera to direct sunlight for a long period of time.
- To prevent the camera from being damaged by moisture, do not use or store the camera in very humid environments, such as in rain or near bodies of water.
- If water accidentally comes in contact with the camera, turn the camera off, remove the battery and the memory card, and dry it completely within 24 hours.
- When you take the camera from a cold environment to a warmer environment, condensation may occur. Please wait for a reasonable period of time before you turn the camera on.
- Before you remove the battery and memory card, the camera should be turned off.
- When you clean the body of the camera, do not use abrasive, alcohol-based or organic cleansers or solvents.
- Use a professional lens cleaning cloth and appropriate cleaner to wipe and clean the lens.
- Download your photos and remove the memory card when you are going to store the camera for a long period of time.
- If this camera is not in use for a long period of time, please keep it in a dry and clean storage location.
- Our company will not pay compensation for any failure of playback including: pictures or videos damaged or unrecoverable by improper operation.

## Safety notes for battery

- Please use a battery that is the same type as the one included.
- Please use the attached charger to charge the battery.
- If battery fluid leaks inside the camera, contact our customer service department immediately. If battery fluid leaks onto your skin, rinse your skin with clean water and seek immediate medical attention.
- Disposal of used batteries should be carried out in accordance with the local (national or regional) regulations.
- To prevent the battery from being damaged, do not drop the battery or allow it to hit solid objects or to be scratched by foreign objects.
- Do not let the battery come in contact with metal objects (including coins) to avoid short circuiting, discharging, excessive heat, or possible leakage.
- Do not attempt to disassemble the battery.
- Do not expose the battery to water. Always keep the battery contacts dry.
- Do not heat the battery or throw it into a fire to avoid a possible explosion.
- Do not store the battery in a hot environment or in direct sunlight.
- If the battery overheats during charging or use, stop charging or stop use immediately. Turn off the product, remove the battery carefully, and wait until it cools down.
- When the camera is stored for a long period of time, remove the battery and keep it in a dry place that is not accessible to infants and children.
- In a colder environment, the performance of the battery could be noticeably reduced.
- When you install the battery, align the battery markings according to the positive and negative markings inside the battery compartment. Never force the battery into the battery compartment.

## Safety notes for memory card

- We suggest buying only well-known, name brand memory cards to ensure peak performance and reliability.
- Format the memory card using the camera before you use it or insert a new one.
- Do not drop the memory card or allow it to hit solid objects to avoid damaging it.
- Do not attempt to disassemble or repair the memory card.
- Do not expose the memory card to water. Always keep it dry.
- Do not remove the memory card when the camera is turned on. Otherwise, the memory card and photo/video files could be permanently damaged.
- Do not directly edit the data on the memory card. Copy the data to your computer before you edit them.
- When the camera is stored for a long period of time, be sure to download your photos and remove the memory card. Store the memory card in a dry environment.
- Do not modify the name of the files or folders of the memory card using your computer. Modifying the file names may cause the files to not be recognized on the camera or a possible permanent error may occur.
- A photo taken with the camera will be stored in the folder that is automatically generated on the memory card. Do not store photos that are not taken using this camera in these folders as the pictures cannot be recognized during the playback.
- When you insert the memory card, make sure the notch of the card matches the markings on the top of the camera card slot.

## Other Safety Notes

- Do not disconnect the power or turn the camera off during the update process. Doing so may cause incorrect data to be written and the camera may not power on later.
- Do not hang the neck strap of the camera around the neck of a child.
- When using your camera on an airplane, observe the relevant rules specified by the airline and FAA regulations.
- Due to the limitations of manufacturing technology, the LCD may have a few dead or bright pixels. These pixels do no effect the quality or performance of the camera, photos or video.
- Do not expose the camera's LCD to water. In a humid environment, only wipe it with a soft and dry cleaning cloth.
- If the LCD screen is damaged, pay particular attention to the liquid crystal in the screen.

If any of the following situations arise, immediately take the steps listed below:

1. If liquid crystal comes in contact with your skin, please wipe with a dry cloth, wash thoroughly with soap, and rinse with plenty of clean water.
2. If liquid crystal gets into your eye, flush the eye immediately with plenty of clean water for at least 15 minutes and then seek medical assistance.
3. If liquid crystal is swallowed, immediately rinse your mouth thoroughly with clean water and induce vomiting. Seek medical assistance.

## WARNING

- Altering, tampering or modifying the any parts of AZ528 camera are unauthorized and will void the manufacturer's warranty and "could" void Federal and/or State Compliance.

# CONTENTS

BEFORE YOU START .....	1	Set your Language, Date/Time after the First Power-On.....	24
SAFETY NOTES .....	6	Resetting your Language.....	25
CONTENTS.....	10	Resetting Date/Time .....	26
GETTING READY.....	15	<b>MODE OVERVIEW .....</b>	<b>27</b>
Accessories Included.....	15	Display Setting .....	27
Install Lens Cap and Neck Strap.....	16	LCD Display.....	28
Part Names .....	17	Overview of the screen icons in photo shooting mode .....	28
Installing Battery and Memory Card.....	19	Overview of the screen icons in movie mode .....	29
Charging Battery .....	21	Overview of the screen icons in playback mode.....	30
Turning Camera On and Off.....	23	How to Take Pictures.....	31
Set your Language, Date/Time .....	24	Using the Mode Dial .....	32

Auto Mode.....	35
Face Beautifier .....	37
Wi-Fi® Mode.....	38
Scene Mode .....	45
Panorama Mode .....	47
Movie Mode.....	50
Custom Settings .....	51

## **BASIC OPERATION..... 53**

Using the Zoom Function.....	53
Focus Setting.....	54
Macro Mode.....	55
Self-Timer Setting.....	56
Flash Mode .....	57

White Balance Setting.....	58
Continuous Shot .....	59
EV Settings .....	60
EV Adjustment.....	60
ISO Adjustment .....	61
Shutter Adjustment.....	61
Aperture Adjustment .....	62
Using Quick Recording .....	62
i Button Function Menu.....	63

## **PLAYBACK MODE..... 64**

Viewing Photos and Videos .....	64
Thumbnail View .....	65



Using Zoom Playback (for still pictures only).....	66	HDR (High Dynamic Range).....	74
Deleting Photos and Videos.....	67	Beautifier .....	74
Slideshow .....	68	Scene.....	75
Continuous Capture Group Playback.....	69	Photo Shooting Settings Menu.....	76
Animation Panorama Play .....	70	Quality .....	77
		AF Assist Beam.....	77
		Digital Zoom.....	77
<b>USING THE MENUS.....</b>	<b>71</b>	Date Imprint .....	78
Photo Setup Menu.....	71	Quick Review.....	78
Expo Metering.....	71	Custom Settings .....	79
Image Size.....	72	Movie Menu .....	80
OIS (Optical Image Stabilization) .....	73	Expo Metering (Exposure Metering).....	80
Cont. AF (Continuous Auto-Focus).....	73	Movie Size .....	81

OIS (Optical Image Stabilization) .....	82	Delete .....	91
Movie Setting Menu .....	83	DPOF (Digital Print Order Format) .....	92
Digital Zoom .....	84	Trim.....	92
Custom Settings .....	84	General Settings Menu .....	93
Playback Menu .....	85	Sound Settings.....	94
Playback Mode .....	85	Power Saver.....	94
HDR (High Dynamic Range).....	86	Language.....	95
Touch-Up .....	86	Zone.....	95
Rotate .....	87	Date/Time.....	95
Resize .....	87	LCD Brightness.....	95
Color .....	88	File Settings.....	96
Playback Settings Menu.....	89	Format .....	97
Protect .....	90		

Copy to Card.....	97
File Numbering.....	98
Reset.....	98
FW Version.....	99

## CONNECTION SETTINGS ...100

Connecting to a Computer.....	101
Setting the USB Mode .....	101
Transferring files to your computer.....	102
Connecting to a PictBridge Compatible Printer .....	103
Setting the USB Mode .....	103
Connecting to your Printer .....	104

Using the PictBridge Menu .....	105
Video System .....	109

## APPENDICES ..... 110

Product Specifications.....	110
Prompts and Warning Messages .....	114
Troubleshooting .....	118

# GETTING READY

## Accessories Included

Your camera box should contain the camera model you purchased along with the following accessories. If anything is missing or appears to be damaged, please contact your retailer first or our customer service center. (The battery chargers may be a little different in shape due to the different countries or regions this camera is sold to. The illustration may not match the actual product.)

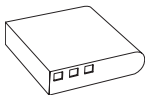

Rechargeable  
Li-ion Battery

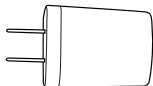

AC Adapter  
(Optional)

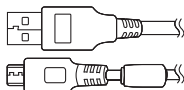

Micro USB Cable

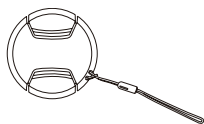

Lens Cap With Strap



Neck Strap



Quick Start Guide



Warranty Card



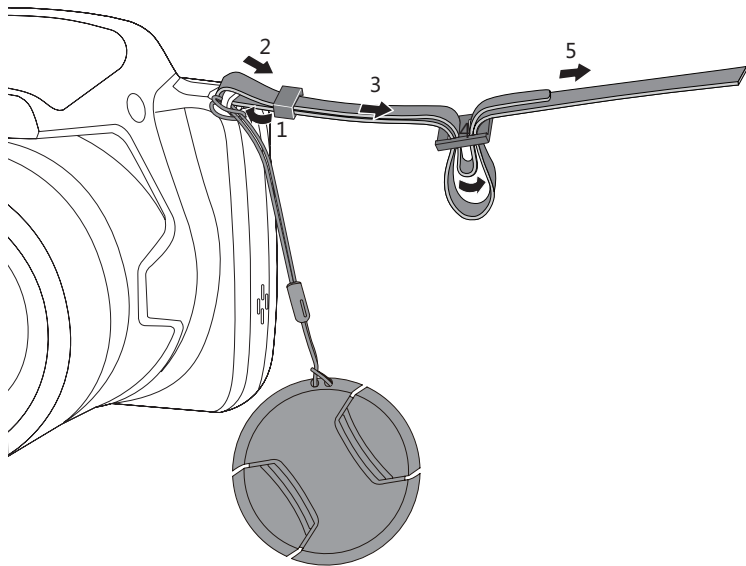

Service Card

## Install Lens Cap and Neck Strap



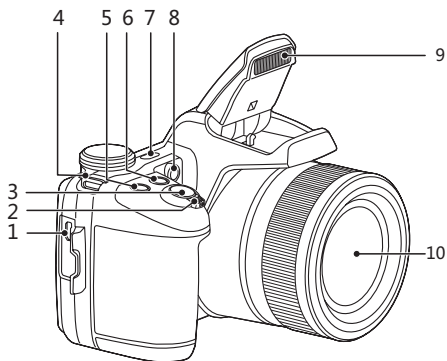





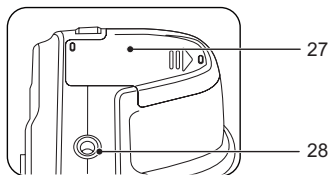
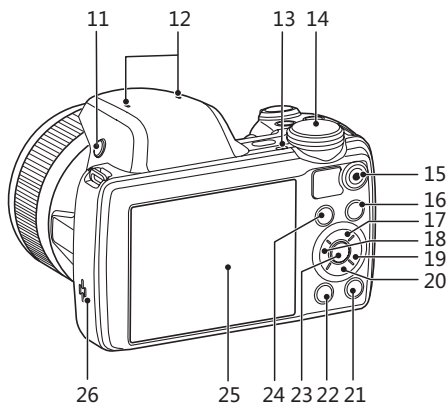



## Part Names



1. Micro USB/AV Port
2. Zoom Lever
3. Shutter Button
4. Strap Eyelet
5.  Exposure Compensation Button
6.  Continuous Shot Button
7. Power Button
8. AF Assist Beam/Self-Timer Lamp
9. Flash Lamp
10. Lens



11. Flash Button
12. Microphones
13. Indicator Lamp
14. Mode Dial
15.  Fast Video Recording Button
16.  Menu Button
17.  AF Button/Up Button
18.  Macro Button/Left Button
19.  Flash Button/Right Button
20.  Delete Button/Self-Timer Button/Down Button
21.  Display Button
22.  Playback Button
23.  SET Button
24.  i Button
25. LCD
26. Speaker
27. Battery Cover Door
28. Tripod Socket (1/4" Standard)

## Installing Battery and Memory Card

1. Open the battery cover according to the direction of arrow.
2. Insert the battery into the battery compartment according to the negative and positive directions as illustrated in the picture. Push the battery down until it locks in place.

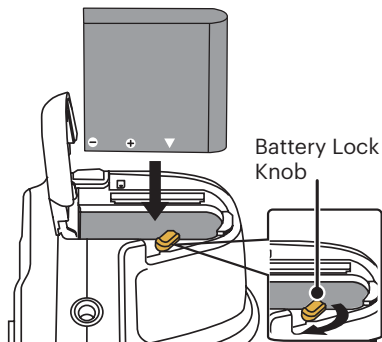
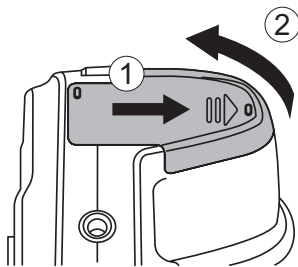



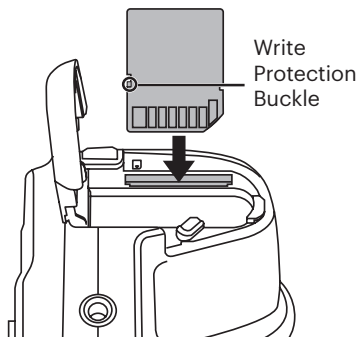

3. Insert the memory card into the memory card slot as shown in the diagram.

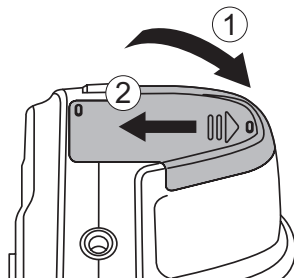

4. Close the battery cover.





-  A standard SD memory card is not included in the camera packaging and needs to be purchased separately. This camera takes a standard (SD/SDHC) memory card. We recommend using a name brand memory card that is Class 4 or higher and has a capacity of 4GB to 32GB. The camera is not compatible with Micro SD, Ultra, Ultra Plus, Extreme, or adapters for any of these other memory cards.
-  To remove your memory card, open the battery cover, gently press the memory card to eject it and remove it carefully.

## Charging Battery

Before you charge the battery, ensure that the battery is inserted properly and the camera is off.

1. Connect the camera and the power charger using the supplied Micro USB cable.
2. Insert the plug of the power charger into the power outlet to charge the battery.

 After the battery is stored for a long period of time, use the supplied power charger to charge the battery prior to use.

 To have maximum battery life, charge the battery for at least 4 hours the first time.

 **Charging indicator:**  
Steady orange: Charging  
The indicator will go out once charging is finished.

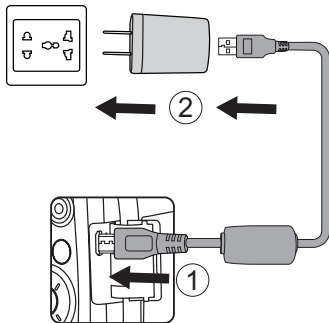

Indicator Lamp

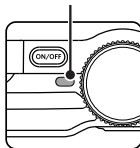

3. When the camera is turned off, you can also connect the camera to your PC using a USB cable to charge the battery.

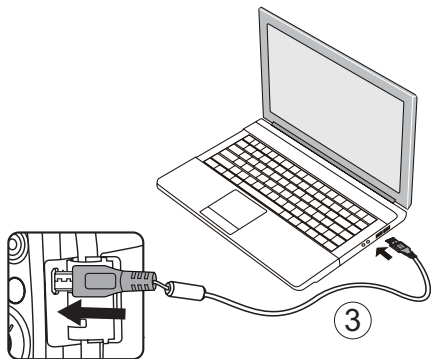

 Please charge the battery indoors between 0°C and 40°C (32°F and 104°F).

## Turning Camera On and Off

Press the power button to turn the camera on. To turn the camera off, press the power button again.

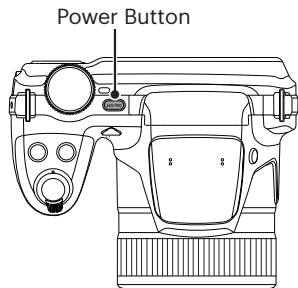

When the power is off, press and hold the  button to power on and enter playback mode.

## Set your Language, Date/Time





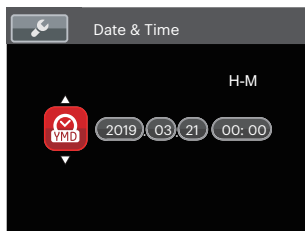



### Set your Language, Date/Time after the First Power-On

1. When you turn the camera on for the first time, the language selection screen will appear.
2. Press the [▲AF] / [▼🗑️🕒] / [◀🌸] / [▶⚡] buttons to select your desired language.
3. After you press the (SET) button to confirm the selection, the Date/Time settings screen appears.
4. Press the [◀🌸] / [▶⚡] button to select the Date/Time to be adjusted: Time is displayed in YYYY.MM.DD HH:MM.
5. Press the [▲AF] / [▼🗑️🕒] button to adjust the value for the selected Date/Time.
6. Press the (SET) button to confirm the time settings and the shooting screen will appear.



## Resetting your Language

After you set your language for the first time, follow the instructions below to reset your desired language.

1. Press the  button, press the [**▲AF**] / [**▼**  ] button to select , and press the  button to enter the menu.
2. Press the [**▲AF**] / [**▼**  ] button to select , and press the  / [**▶** ] button to enter the menu.
3. Press the [**▲AF**] / [**▼**  ] button to select [Language] and press the  / [**▶** ] button to enter the menu.
4. Press the [**▲AF**] / [**▼**  ] / [**◀** ] / [**▶** ] buttons to select your desired language and press the  button to confirm.
5. Press the  button and the shooting screen appears.

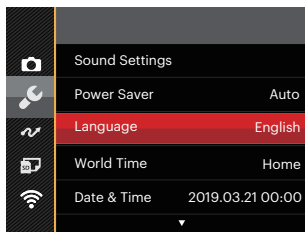

## Resetting Date/Time

After you set your Date/Time for the first time, follow the instructions below to reset date and time.

1. Press the button, press the [**▲AF**] / [**▼** ] button to select , and press the button to enter the menu.
2. Press the [**▲AF**] / [**▼** ] button to select , and press the / [**▶** ] button to enter the menu.
3. Press the [**▲AF**] / [**▼** ] button to select [Date & Time] and press the / [**▶** ] button to enter the menu.
4. Press the [**◀** ] / [**▶** ] button to select the Date/Time to be adjusted: Time is displayed in YYYY.MM.DD HH:MM.
5. Press the [**▲AF**] / [**▼** ] button to press the value for your selected block. After you finish your settings, press the button to confirm.
6. Press the button and the shooting screen appears.

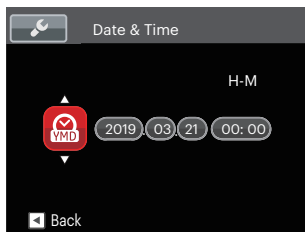
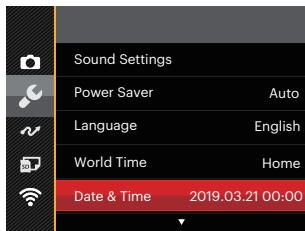

# MODE OVERVIEW

## Display Setting

Press the **DISP** button to display the settings: Classic, Full, Off.

**Classic:** Displays the camera parameters on screen



**Off:** Does not display any additional icons on screen

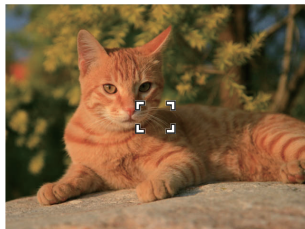

**Full:** Camera parameters with Grid and Histogram

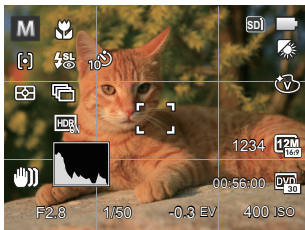



## LCD Display

### Overview of the screen icons in photo shooting mode

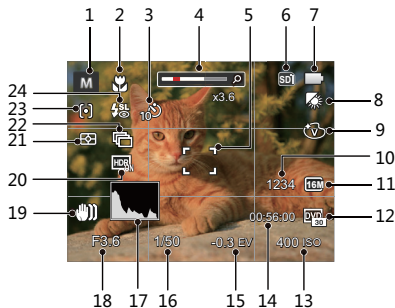

1 Shooting Mode

2 Macro Mode

3 Self-Timer

4 Zoom Display (By turning the Zoom Lever)

5 Focus Frame

6 SD Memory Card/Built-in Memory

7 Battery Status

8 White Balance

9 Color Effect

10 Number of Remaining Shots

11 Image Size

12 Video Quality

13 ISO Value

14 Remaining Recording Time

15 Exposure Compensation

16 Shutter Speed

17 Histogram

18 Aperture Value

19 OIS (Optical Image Stabilization)

20 HDR

21 Expo Metering

22 Continuous Shot

23 AF Mode

24 Flash Mode

## Overview of the screen icons in movie mode

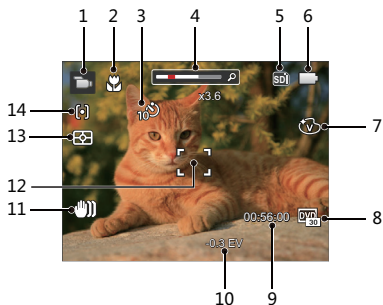

- 1 Movie Mode
- 2 Macro Mode
- 3 Self-Timer
- 4 Zoom Display (By turning the Zoom Lever)
- 5 SD Memory Card/Built-in Memory
- 6 Battery Status

- 7 Color Effect
- 8 Video Quality
- 9 Remaining Recording Time
- 10 Exposure Compensation
- 11 OIS (Optical Image Stabilization)
- 12 Focus Frame
- 13 Expo Metering
- 14 AF Mode

 For optimal video shooting, it is recommended that an SDHC memory card be used.

 Optical Zoom and Digital Zoom can be adjusted (208X in total). Digital Zoom can be adjusted to 4X.

## Overview of the screen icons in playback mode

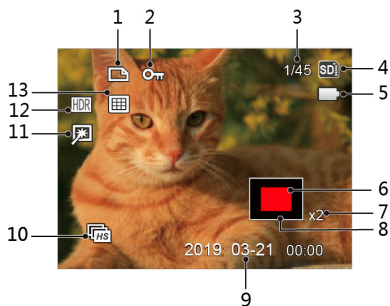

- 1 DPOF File
- 2 File Protection
- 3 Memory Space (indicating the current number of photos and total number of photos)

- 4 SD Memory Card/Built-in Memory
- 5 Battery Status
- 6 Zoom Magnification Area
- 7 Image Zoom Ratios
- 8 Image Zone
- 9 Shooting Date
- 10 Continuous Capture Group Playback
- 11 Touch-up
- 12 HDR
- 13 Date Folder

## How to Take Pictures

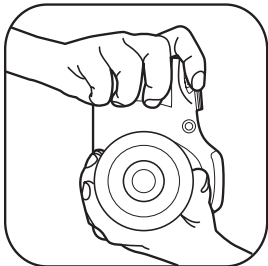
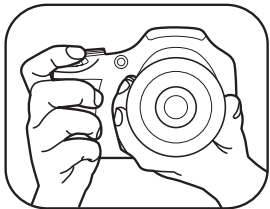



1. Hold the camera securely with both hands, being careful not to block the flash and lens with fingers.
2. Point the lens toward the object you want to take a picture of.
3. Use the zoom lever to select Tele or Wide position to zoom in or out on your subject.
4. Press the shutter button down half-way to allow the camera to focus on your subject.
5. When the frame around your subject turns green and the LCD is focused to your liking, push the shutter button down completely to take the picture.

## Using the Mode Dial

This camera provides a convenient mode dial that allows you to manually switch between different modes with ease. The available modes are listed below:

Mode Name	Icon	Description
Auto Mode		In this mode, the optimal conditions for taking pictures will be set based on the subject and environment. It is the most commonly used mode for taking pictures.
Program AE	<b>P</b>	Under different scenes, the user can switch the ISO and EV value according to personal preference, the camera can automatically set the shutter speed and aperture value.
Shutter priority	<b>S</b>	Setting allows you to adjust the shutter speed / EV value and ISO value. The camera automatically sets the aperture value based on the shutter speed and ISO value to get the most appropriate exposure value.
Aperture priority	<b>A</b>	In this mode, you can adjusting the aperture size, EV and ISO values. The large aperture is to highlight the object focused through blurring the background, while the small aperture is for clear focusing on both the background and the object.





Manual Mode	<b>M</b>	This mode is for manually setting the aperture, shutter speed and ISO value.
Face Beautifier		This mode automatically enhances facial features with skin softening touches and eye brightening capabilities.
Wi-Fi Mode		Enable image transmission and remote control by connecting smart device with Wi-Fi.
Scene Mode	<b>SCN</b>	Choose from 13 different pre-set scene types and effects for your photos.
Movie Mode		Record videos.
Custom Settings	<b>CS</b>	The user can store frequently used shooting modes and parameters. Switching to this mode enables quick adjustment.

## Mode: PSAM

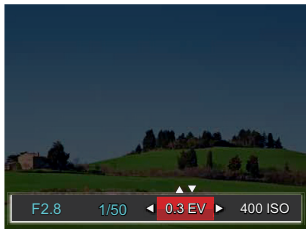
Follow the steps below to adjust the parameters:

1. Rotate the mode dial to select a mode you want, press the  button to configure settings.



2. Press the [] / [] button to select an adjustment setting.
3. Press the [] / [] button to adjust the parameters.
4. Press the  button to confirm the settings and enter the shooting screen.

Please refer to the table below for any nonadjustable options in **PSAM** mode:

(O: Available X: Not Available)

Options Mode	Aperture	Shutter	EV	ISO
<b>P</b>	X	X	O	O
<b>S</b>	X	O	O	O
<b>A</b>	O	X	O	O
<b>M</b>	O	O	X	O



Please note that even if an option is not able to be adjusted in a particular mode, its value will still be displayed on the shooting screen.

## Auto Mode 📷

The camera will automatically detect the most suitable scene to capture the best pictures.



## Auto Mode 📷

The camera automatically adjusts the exposure and focus to ensure the best possible pictures.

## Landscape Mode 📷

For landscapes, automatically adjusts the exposure to match the background.



## **Portrait Mode**

Most suitable for capturing people with focus on their faces.

## **Night Portrait**

When you take portraits at night or in low light conditions, automatically adjust the exposure for people and night scenes.

## **Backlit Portrait**

When the sun or any other light source is behind you, automatically adjusts the foreground exposure to produce the best pictures possible.

## **Night Mode**









For night scenes, automatically increases the ISO value to compensate for low light.

## **Macro Mode**



To produce more detailed close-ups, will automatically engage the camera's Macro Mode and automatically focus the lens.

## Face Beautifier

The camera is set to automatically adjust camera exposure for realistic portrayal of skin tones.

1. Turn the mode dial to select face beautifier mode .
2. Press the  button and press the [AF] / [ ] button to select .
3. Press the [ ] button to select an option and press the  button to confirm and return to photo shooting mode.



-  Effect 1: Skin Soften
-  Effect 2: Skin Soften+Eye Brightening
-  Effect 3: Skin Soften+Eye Brightening+Eye Enlargement

## Wi-Fi® Mode



Enable image transmission and remote control by connecting smart device with Wi-Fi®.

Before utilizing Wi-Fi® Mode, please review the following:

- Your smart device operating system version needs to be iOS 14 or higher, or Android 8.0 or higher. If not, please upgrade your smart device before using the App.
- Please do not use in places having high intensity magnetic field, electrostatic and electric wave interference (for example near a microwave oven), which may cause failure in receiving signals.
- To maintain a connection, please keep the camera within 10 meters (32.8 feet) without signal shielding interference.
- Please do not use Wi-Fi® connection functionality on a plane.
- The camera and the smart device can only be connected one to one.

## Downloading the App package:

Download a dedicated installation package from the application store (App name: PIXPRO Remote Viewer  ) and then install it.

- Android devices : Search and download the App “PIXPRO Remote Viewer”  in Google play, and install it following the instructions on the interface.
- iOS devices : Search and download the App “PIXPRO Remote Viewer”  in App store, and install it following the instructions on the interface.



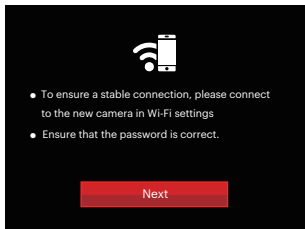

Rotate the mode dial to  and then enter the Wi-Fi® selection interface.



- Next: Enter the SSID interface.

 Rotate the mode dial to disconnect.

### Settings of Camera:

Press the [▲AF] / [▼  ] button to select options to be adjusted, and press the  button to enter the setting interface.

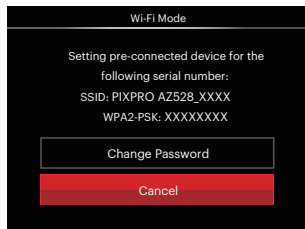

- Change Password: Enter the WPA2 PSK password refresh interface.

Yes: Create a new WPA2 PSK password.

No: Back to previous page.

- Cancel: Back to previous page.

### Settings of Smart Device:

1. Enable the Wi-Fi® of smart device and then search surrounding wireless devices.
2. Select the name of camera SSID to be connected and then input the eight-digit number password after WPA2-PSK on the camera.
3. Click the icon of the PIXPRO Remote Viewer App  to enable the App.

### Set up completion:

Once the App is connected to the camera, functional operation can be enabled on the smart device.



Every AZ528 camera is shipped with a default factory Wi-Fi® password that is randomized and unique to that camera and will not change unless you wish to reset the password with a new randomly generated password. If you wish to change the Wi-Fi® password in your AZ528 from the assigned, unique factory password, you can do so by selecting and using the refresh setting. If “refresh” is selected, a new random password will be generated and saved in the camera until changed or if you use the “Reset” function. If you reset your AZ528 to the factory settings, then the initial, randomly factory assigned and unique Wi-Fi® password will be restored to your camera. (Please refer to Reset instructions on page 98).

## Display of Wi-Fi® Connection Status

The Wi-Fi® has successfully connected but App is not enabled:

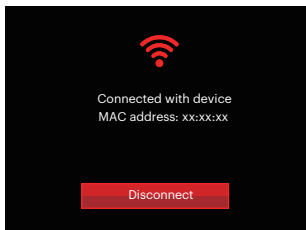

The Wi-Fi® has successfully connected and App is enabled:

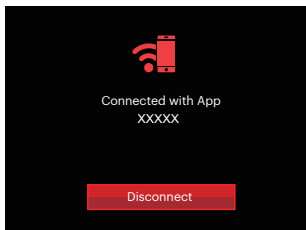

To Disconnect from Wi-Fi®:



- No: Keep Wi-Fi® connected and back to previous page.
- Yes: Disconnect and back to Wi-Fi® connection screen.



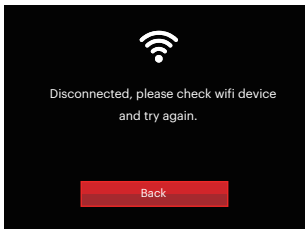



Disconnected from smart device Wi-Fi®:





- Back: Back to the SSID interface.

## Settings

The name of this camera can be changed under Wi-Fi® settings.

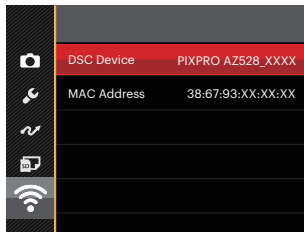
1. In other modes, press the  button and press the up/down button to select . Press the  button to enter the menu.
2. Press the up/down button to select  and press the  button or right arrow button to enter the menu.
3. Press the up/down buttons to select options to be adjusted and then press the  button to enter the menu.



4. Press the  button to confirm settings and then skip the menu.



## DSC Device

The default name of DSC Device is 「PIXPRO AZ528\_XXXX」. Change the name of DSC device through typing.



Meanings of interface icons:

Icon	Description
	Backspace
	Switch between capital and lowercase letters
	Move the Cursor
	Switch the symbol input
	Space

## MAC Address

Check the wireless MAC Address of this camera.

## App Operating Instructions

Refer to the "PIXPRO Remote Viewer User Manual" located on the web:

Americas / Europe









<http://kodakpixpro.com/Americas/support/downloads.php>

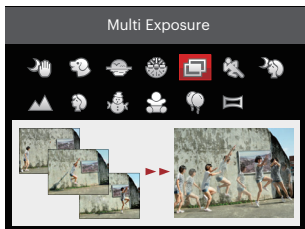











## Scene Mode SCN

The user can select an appropriate mode from the 13 scene modes according to the type of environment you are shooting in. The camera then configures the most appropriate settings for the best possible photos.

1. Rotate the mode dial to select **SCN** .
2. Press the [**▲AF**] / [**▼**  ] / [**◀** ] / [**▶** ] buttons to select a scene, and press the  button to confirm.





3. To change to a different scene, please press the  button and then the  button and finally the [**▲AF**] / [**▼**  ] / [**◀** ] / [**▶** ] buttons to reselect the scene.

Scene	Description
 Handheld Night	Reduce blur when shooting low light/ illuminated scenes.
 Cat/Dog	Rapidly identify pet (dog/cat), capture the dynamic moment of pet.
 Sunset	For sunsets. Capture subjects in strong sunlight.
 Fireworks	For fireworks at night. The use of a tripod is recommended.
 Multi Exposure	Suitable for shooting moving objects (as many as 7) in the same background.
 Sport	For fast-moving subjects. Capture sharp action shots without blur.
 Night Portrait	For portraits against night time scenery. The use of a tripod is recommended.
 Landscape	For landscapes and outdoor shots. Vivid reproduction of greens and blues.
 Portrait	Most suitable for capturing people with focus on their face.
 Snow	For snowy scenes. Reproduces natural, clear, white scenes.
 Children	For kids and pets. Flash is disabled for eye protection.
 Party	Suitable for taking indoor party photos, even under complicated lighting conditions.
 Panorama Mode	For shooting up to 360-degrees of landscape. This feature allows you to capture a panoramic view that will have significantly more content than a single photograph.



## Handheld Night

-  Quickly take 4 photos below 8M (including 8M) and then overlap as a clear night image.

## Pet Mode

-  When a cat /dog face is detected, a white focus frame appears. The camera will take a picture and save it regardless of whether the focus is successful (if successful, there appears a green focus frame; if not, there is an orange frame).
-  At most, 10 dog/cat faces can be detected at one time.







## Multi Exposure

-  Keep camera steady before shooting. Press and hold the Shutter button to take 7 photos continuously when it will stop automatically. To stop shooting, release the Shutter button in the midway.
-  Objects shall be moved only from left to the right in order to be recorded. Objects moving from other directions would not be recorded.
-  Shooting effect will be influenced if object is moving too fast or too close.

## Panorama Mode





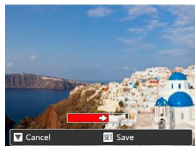

Follow the arrow while keeping the camera steady to seamlessly shoot an ultra-wide scene of up to 360 degrees.

Follow the steps below:

1. Select the Panorama Mode (  ) and then press the  button to confirm.
2. Press the [AF] / [] / [] / [] button to select a shooting direction. (Should you not select the direction, the default shooting direction is "right"). 2 seconds later, the camera is ready to take pictures. You can also press the  button or press the Shutter button halfway down to be ready to take pictures.
3. Compose your shot on the LCD and half press the shutter button to focus on the subject. After focusing, fully press the down shutter button to take the first picture. At this time, the process dialog of panorama mode stitching appears on the screen.





4. Move the camera according to the set direction. When the range of motion does not exceed the range that the camera can detect, the progress dialog along the indication arrow partially turns red. When it completely turns red, panorama mode shooting is finished.

-  Panoramic image can be played back by the method of flash playing. Please see the animation panoramic playback on page 70.
-  During shooting, the flash, self-timer, macro modes and exposure compensation are not available. Focus adjustment is also not available at this time.
-  During panorama mode shooting, press the  button to interrupt shooting and save the current pictures taken. Press the  button to cancel shooting and not to save the previously taken pictures.
-  During panorama mode shooting, when the moving direction of the camera is wrong or the angle deviates from the internal settings, the LCD shows a warning message [Improper alignment. Please try again.] and the current pictures taken are saved.



## Movie Mode

Switch to this mode to record videos.

Follow the steps below:

1. Rotate the mode dial to select , and it will enter the movie screen.
2. Press the  button or the Shutter button to start recording.



3. Press the  button or the Shutter button again to stop recording, save it automatically and then the camera will return to the movie screen.
-  In the recording process, you can rotate the zoom lever to zoom in or out on the subject.



## Custom Settings CS

The user can store the frequently used shooting modes and parameters and switch to this mode for quick adjustment.

### Settings under CS mode (unset state or state after reset):

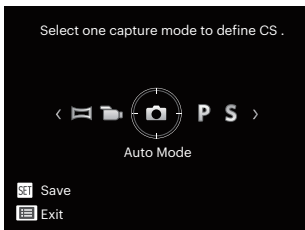
1. Turn the mode dial to select the **CS** mode, and enter the setup screen, as shown in the figure below:



2. As shown in the picture, press the [] / [] button to select a capture mode that you want to define as **CS**, and press the (SET) button to enter the shooting screen.



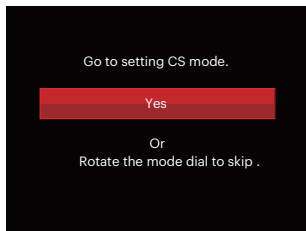



3. As shown in the picture, press the (MENU) button to confirm setting or to exit without setting by turning the mode dial.



### For setting under other modes (use this method to select a different custom setting):

1. Select any mode or scene mode to be stored.
2. Set your desired parameters in the current mode.



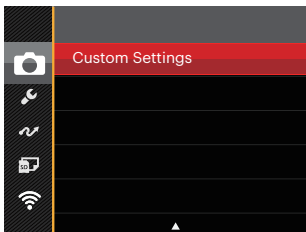

3. Press the  button and then the **[▲AF] / [▼🗑️🔄]** button to select  , and press the  button to enter the menu.
4. Press the **[▲AF] / [▼🗑️🔄]** button to select  , and press the  / **[▶⚡]** button to enter the menu.
5. Press the **[▼🗑️🔄]** button to select **[Custom Settings]** and then press the  / **[▶⚡]** button to enter the menu.

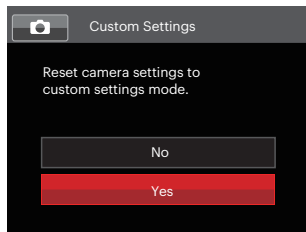

6. Select **[Yes]** to save or **[No]** to cancel.



7. Rotate the mode dial to switch to **CS** .
8. The photo settings you stored the last time are invoked.

-  When the **CS** mode is used for the first time, there is no preset parameter stored in the **CS** mode.
-  If you want to remove the parameter setting of **[Custom Settings]** , please see the reset function on page 98 to operate.

# BASIC OPERATION

## Using the Zoom Function

Your camera is equipped with two types of zoom functions: Optical Zoom and Digital Zoom. Toggle the Zoom Lever of the camera to zoom in or out on the subject while taking pictures.

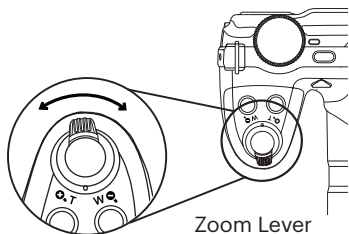

When the Optical Zoom reaches the threshold as Digital Zoom, release and turn the Zoom Lever to T to switch between the Optical Zoom and Digital Zoom.



Zoom Indicator

## Focus Setting

This function can be adjusted in **PSAM** mode, please follow the steps below to configure the settings:

1. Press the [**▲AF**] button to enter the Focus menu.



2. Press the [**◀** / **▶**] button to select the following 3 modes:

- [**□**] Single-AF  
The focus frame appears on the center of the LCD to focus on the subject.
- [**□**] Multi-AF  
The camera automatically focuses the subject in a wide area to find the focus point.
- [**□**] Object Tracking  
Smart tracking of the object in motion under the focusing shooting.

3. Press the [**SET**] button to confirm the settings and exit the menu.



Once enabled, Object Tracking will only work when lens is focused on the object.

## Macro Mode



The Macro Setting is ideal for shooting small objects or close-up photos. This mode allows you to focus on subjects very close to the camera.

It can be adjusted in **PSAM** + [📷] mode. Please follow the steps below to configure the settings:

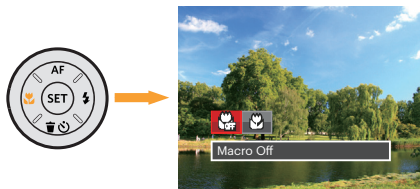
1. Press the [📷] button to enter the Macro menu.



2. Press the [📷] / [🔋] button to select the following 2 modes:

-  Macro Off  
Select this option to disable Macro.
-  Macro On  
Select this option to make focusing on the object closer to the lens. (At the W side, the shooting distance should be more than 1 cm).

3. Press the (SET) button to confirm the settings and exit the menu.

## Self-Timer Setting

Use this function to take pictures at pre-set intervals. The camera can be set to shoot after 2 seconds, 10 seconds after pressing the shutter or when a smile is detected. It can be adjusted in **PSAM** mode. Please follow the steps below to configure the settings:

1. Press the [▼📷🕒] button to enter the Self-Timer menu.



2. Press the [📷] / [▶🔋] button to select the following 4 modes:

- Self-Timer Off  
Disables the Self-Timer.
- Self-Timer 2 sec  
A single picture is shot 2 seconds after the Shutter Button is pressed.
- Self-Timer 10 sec  
A single picture is shot 10 seconds after the Shutter Button is pressed.

- Self-Timer Smile  
Press the Shutter Button and a picture will be taken immediately after a smile is detected.

3. Press the (SET) button to confirm the settings and exit the menu.

- When enabling the Self-Timer, pressing the Shutter Button or the [▼📷🕒] button will select the highlighted Self-Timer option and return to the shooting screen, and keep the Self-Timer setting.
- When enabling the smile detection, pressing the Shutter Button or the (SET) button will select the Self-Timer smile option (if highlighted) and return to the shooting screen, and keeping the Self-Timer smile setting.

## Flash Mode

The flash provides supplemental light for a scene. The flash is usually used when shooting against the light to highlight the object. It is also suitable for metering and shooting in darker scenes to improve the exposure.

It can be adjusted in **PSAM+** mode. Please follow the steps below to configure the settings:

1. Press the Flash Button  to pop up the flash.

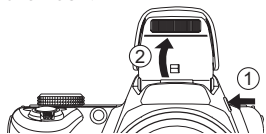

2. Press the [] button to enter the Flash Settings Menu.



3. Press the [] / [] button to select the following 6 modes:



- Force Off  
Flash is turned off.



- Flash Auto  
Camera flash goes off automatically based on existing light conditions.



- Fill Flash  
The flash goes off when a picture is taken, supplementing the existing light in a scene and helping to eliminate shadows.



- Slow Sync.  
This allows you to take pictures of people at night that clearly show both your subjects and the night time backdrop. The use of a tripod is recommended when shooting with this setting.



- Slow Sync. + Red-Eye  
Use this mode for slow synchro shots with red-eye reduction.



- Red-Eye Reduction  
The camera emits a brief pre-flash before the picture is taken to reduce red-eye effects.

4. Press the  button to confirm the settings and enter the shooting screen.

## White Balance Setting



The white balance function allows adjustment of the color temperature for different light sources.





It can be adjusted in **PSAM** mode. Please follow the steps below to configure the settings:

1. Press **SET** button to enter the White Balance menu.



2. Press the **[◀🌸]** / **[▶⚡]** button to select the following 8 modes:

- **AUTO WB** AWB
-  Daylight
-  Cloudy

-  Fluorescent
-  Fluorescent CWF
-  Incandescent
-  Manual WB  
(Fully press the Shutter button to detect the white balance value)
-  Color Temp. (1900K-10000K)  
Press the **[▲AF]** / **[▼🗑️🕒]** button to "Adjust the K value";  
Press the **[◀🌸]** button to exit the K value.

3. Press the **SET** button to confirm the settings and exit the menu.



## Continuous Shot

This function can be adjusted in **PSAM** mode. Please follow the steps below to configure the settings:

1. Press the  button to enter the Continuous Shot menu.





2. Press the  /  button to select the following 5 modes:

-  Single  
Capture a single shot only.
-  Continuous Shot  
Take several pictures at a time.

-  Cont.Shot-High Speed (VGA)  
For continuous shot with VGA pixel.

-  Cont.Shot-Fast (4M)  
For continuous shot with 4M pixels.

-  Time-Lapse  
Take pictures based on the preset interval (30sec/ 1min/ 5min/ 10min).

3. Press the  button to confirm the settings and exit the menu.
4. Press the Shutter button to start continuous shooting.







-  In Continuous Shot mode, the flash is automatically set to Force Off in order to achieve quick succession of shots.



## EV Settings

The EV function menu of the camera includes functions, such as EV (Exposure Value) Adjustment, ISO, Shutter Adjustment, Aperture Adjustment, etc. Using the appropriate function settings can improve your pictures.

Please follow the steps below to set:

1. Press the  button to display the settings screen.
2. Press the [] / [] button to select the setting options.
3. Press the [AF] / [] button to adjust the option values.
4. Press the  button to complete the setting and enter shooting mode.

### EV Adjustment

Set up to adjust the picture brightness. In the case of a very high contrast between the photographed object and the background, the brightness of the picture can be appropriately adjusted. (Adjustable in **PSA** +  Mode)

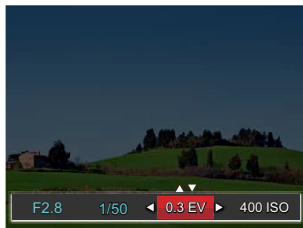

The adjustable range of exposure value is from EV -3.0 to EV+3.0.

## ISO Adjustment

ISO allows you to set the sensitivity of the camera sensor. Please use a higher ISO value in darker places and a lower value in brighter conditions. (Adjustable in **PSA M** Mode).

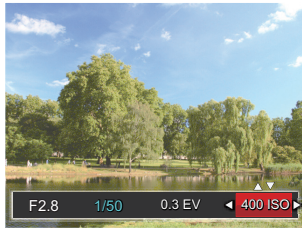

Options for ISO value: Auto, 100, 200, 400, 800, 1600 and 3200.

## Shutter Adjustment

For shutter speed, the camera may automatically set the aperture value corresponding to the manually set shutter speed so as to obtain a most suitable exposure value. The movement of object may be shown by adjusting the shutter speed. High shutter value can help you more clearly capture fast moving objects while low shutter value can better show the movement of objects. (Adjustable in **S M** Mode).



## Aperture Adjustment

You can adjust the aperture size value. Selecting a large aperture opening will emphasize the point of focus and show a blurry background and foreground. A small aperture opening will keep both the background and main object in clear focus. (Adjustable in **AM** Mode)

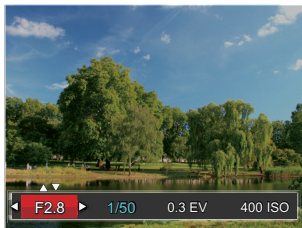

## Using Quick Recording

In shooting mode, press the  button to begin recording video.

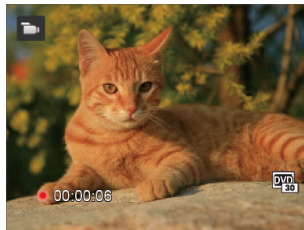





After recording, press the  button again or press the Shutter Button to stop recording. The camera will save the video and return to the shooting screen.

## i Button Function Menu

The Image Color Setting allows you to select different color effects.







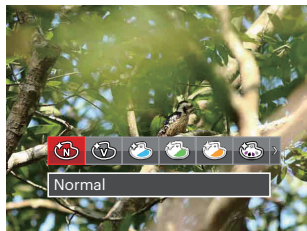





















It can be adjusted in **PSAM**  mode. Please follow the steps below to configure the settings:

1. Press the  button to select the Image Color Setting Menu.
2. Press the [] / [] button to select the Image Color Setting options.

 (  ) represents options that are available in Movie mode.







There are 20 Image Color options in photo shooting mode **PSAM**:

 Normal (  )	 Sepia (  )	 Vignetting
 Vivid (  )	 Partial Color-Red (  )	 Salon
 Japan Style	 Partial Color-Blue (  )	 Fish Eye
 Italian Style	 Partial Color-Yellow (  )	 Reflection
 French Style	 Partial Color-Green (  )	 4 Grids - Stylish(2M)
 Punk	 Negative	 Sketch
 Black and White (  )	 Dreamy	

# PLAYBACK MODE

## Viewing Photos and Videos

For viewing previously taken photos and videos on the LCD:

1. After pressing the  button, the last photo or video clip taken will be displayed on the LCD.
2. Press the [] / [] button to scroll through the photos or video clips stored in the internal memory or on the memory card.
3. To play a selected video clip, press the  button to enter the Movie Playback mode. An operation guide appears on the screen when playing back a video. Press the appropriate buttons to enable the corresponding functions.

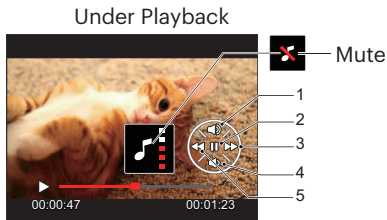

1	Increase Volume
2	Pause
3	Fast Forward
4	Decrease Volume
5	Rewind

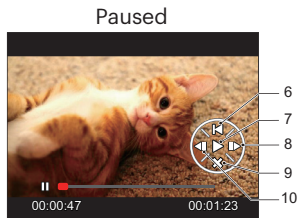

6	Back to the beginning of the video
7	Play
8	Frame Forward
9	Cancel playback
10	Frame Backward





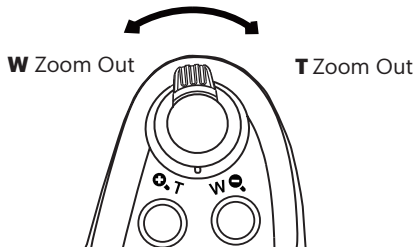

## Thumbnail View

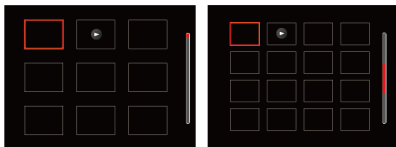
When in Playback Mode, rotate the Zoom Lever counter clockwise to the **W**  position to display thumbnail images of the photos and videos on the screen.



1. Slide the Zoom Lever to switch between 3x3 and 4x4 thumbnails.







2. Press the [**▲**AF] / [**▼**  ] / [**◀**  ] / [**▶** ] buttons to select a picture or video clip to view and press the **SET**  button to restore it to the original size.







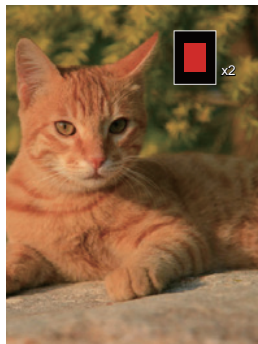
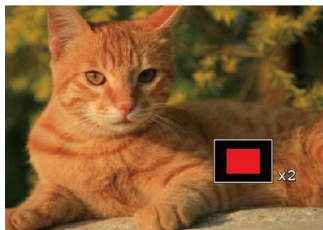

When the icon  appears, it means this is a video file.

## Using Zoom Playback (for still pictures only)

When playing back photos, you can also use the Zoom Lever to zoom in on the photos 2 to 8 times.

1. Press the  button to switch to Playback Mode.
2. Press the  /  button to select a picture to be zoomed in on.
3. Rotate the Zoom Lever clockwise to   to zoom in.
4. The screen will display the number of times and area of the photo zooming operation.



5. Press the    /  /  buttons to navigate and select a part of the image to be zoomed in on.
6. Press the  button to return the image to its original scale.



Movie images cannot be magnified.

## Deleting Photos and Videos

In Playback Mode, press the [▼🗑️🕒] button to delete your photos and videos.

To delete photos or videos:

1. Press the [⏮] button to switch to Playback Mode.
2. Press the [◀️🌸] / [▶️📺] button to select the photos and videos to be deleted.
3. Press the [▼🗑️🕒] button and the deletion screen is displayed.

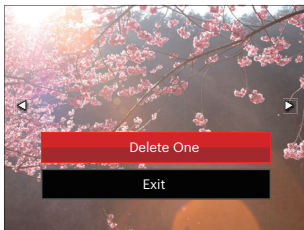

4. Press the [▲AF] / [▼🗑️🕒] button to select [Delete One] or [Exit] and press the [SET] button to confirm.



Erased photos/video clips cannot be recovered.







Please refer to page 91 for instructions on deleting more than one image at a time.





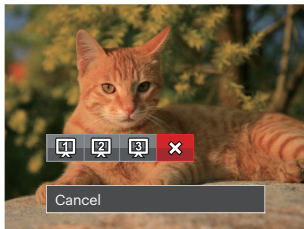

## Slideshow

This setting allows you to view all the stored images as a slideshow.





1. Press the  button to enter playback screen.
2. Press the  button to enter slide option.
3. Press the  /  button to select the slideshow playing option or [Cancel] to return to the playback screen.



4. Press the  button to confirm the setting.
-  The Continuous Capture Group Playback may be displayed by slideshow.
  -  Pictures rotate automatically during a slide show.
  -  Slide playing function supports movie playing.

## Continuous Capture Group Playback





Cont.Shot-High Speed (VGA) and Cont.Shot-Fast (4M) can make continuous capture for group image playback.

1. Press  button to enter playback screen.
2. Press the [] / [] button to select Cont. Group.
3. Press  to start playback.



## Animation Panorama Play

Panoramic Animation Playing is when full sized images are played in accordance with the shooting direction. After playing, it will automatically return to the initial panorama screen.

1. Press the  button to enter Playback Screen.
2. Press the [] / [] button to select animated panoramic photos.
3. Press the  button to play in selected shooting direction.



-  In the process of Panoramic Animation Playback, press the [  ] button () to stop playing and return to the Playback Screen.

# USING THE MENUS

## Photo Setup Menu

Mode: PSAM SCNCS

1. In Photo Shooting Mode, press the button to enter the Photo Setup menu.
2. Press the [] / [] button to select the item to be set.



3. Press the [] / [] button to select an option and press the button to confirm.

Refer to the following pages for more details about each setting.

## Expo Metering

Use this setting to select the “target” size of the camera’s field of view to be metered.



- AiAE (Artificial Intelligence AE): Evaluates the light intensity at multiple points in the frame and automatically determines the best value for the light meter.
- Spot: For metering the block displayed in the center of the screen.
- Center: For metering the object in the center of the screen.



It can be adjusted in all modes except for Panorama Mode.

## Image Size

The size setting refers to the image resolution in pixels. A higher image resolution allows you to print that image in larger sizes without sacrificing the image quality.



- **16M** Size: High quality printing
- **14M** Size: Full size printing
- **12M** Size: 16:9 display
- **10M** Size: Poster printing

- **5M** Size: A3 printing
- **3M** Size: A4 printing
- **2M** Size: 4"x 6" printing
- **VGA** Size: E-Mail



 The larger the number of recorded pixels, the larger the file size and the fewer files that can be saved on your memory card.

## OIS (Optical Image Stabilization)

This mode can help reduce photo blur caused by unsteady hands and low light.





-  OIS: Off
-  OIS: On

-  Use this image stabilization mode in dark environments.
-  Shooting in a windy or unstable environment (such as a moving vehicle) may cause blurry images.
-  It is recommended to turn off OIS when using a tripod.

## Cont. AF (Continuous Auto-Focus)

Enable Continuous AF to be able to continuously focus automatically when taking pictures.



-  Cont.AF: Off
-  Cont.AF: On

## HDR (High Dynamic Range)

Use this setting to control wide dynamic image range when taking static pictures. Photos with extreme contrast of bright and dark areas will still maintain distinguishable detail and depth. (Use of a tripod is recommended with this setting)



-  HDR: Off
-  HDR: On





In a setting with extreme contrast (very dark or very bright), this function can be used to shoot better photos.

## Beautifier

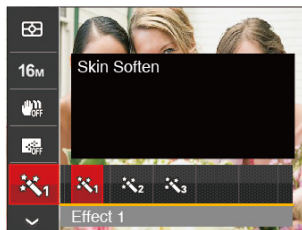
Select an effect of the Face Beautifier Mode.



-  Effect 1: Skin Soften
-  Effect 2: Skin Soften+Eye Brightening
-  Effect 3: Skin Soften+Eye Brightening +Eye Enlargement

Please refer to P37 for more detailed instructions.

## Scene

Select the scene mode under the SCN mode.

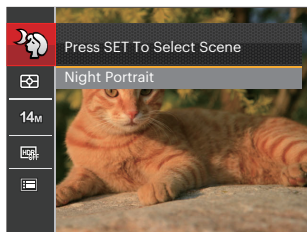

Please refer to P45 for more detailed instructions.

Shooting menu in the Photo Shooting Mode  
(O: Available X: Not Available)

Options	Photo Shooting Modes					
		P	S	A	M	
	O	O	O	O	O	O
16M	O	O	O	O	O	O
	X	O	O	O	O	O
	X	O	O	O	O	O
	X	O	O	O	O	X
	X	X	X	X	X	O









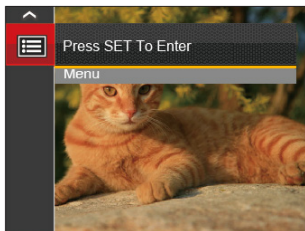













## Photo Shooting Settings Menu

Mode:  P S A M  SCN CS

1. Press the  button in Photo Shooting Mode and press the [ AF] / [  ] button to select  .



2. Press the  button to enter the menu.
3. Press the [ AF] / [  ] button to select  , and press the  / [ ] button to enter the menu.
4. Press the [ AF] / [  ] button to select the item to be set and press the  / [ ] button to enter the menu.
5. Press the [ AF] / [  ] button to select an option and press the  button to confirm.

## Quality

The Quality Setting can be used to adjust the image compression ratio.

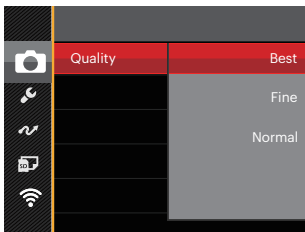

There are three options for picture quality:

- Best
- Fine
- Normal

## AF Assist Beam

In a darker environment, AF Assist Beam can be turned on for better focus.

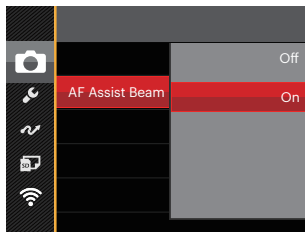

## Digital Zoom

Turn on or off the digital zoom.

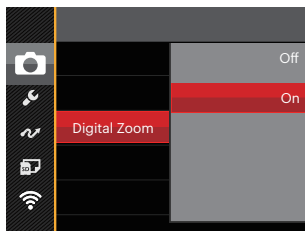

## Date Imprint

Include a Date/Time stamp on the photo image.

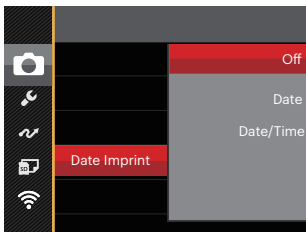

- Off
- Date
- Date/Time

## Quick Review

This option enables a quick review of the photos immediately after they are taken. Each photo is displayed on the LCD based on the selected time.

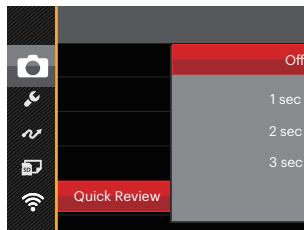

There are 4 options:

- Off
- 1 sec
- 2 sec
- 3 sec

## Custom Settings

Custom Settings stores the current photo shooting mode or scene mode and its parameters. The stored mode and parameters are retrieved in **CS** mode.

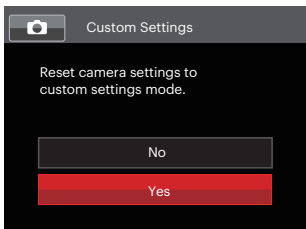

There are 2 options:

- No
- Yes





In **CS** mode, select [Custom Settings] the camera will enter the setting menu as shown below:







## Movie Menu

Mode: 

1. Rotate the mode dial to select  and press the  button to enter the Movie menu.





2. Press the  /  button to select the item to be set.
3. Press the  /  button to select an option and press the  button to confirm.

## Expo Metering (Exposure Metering)

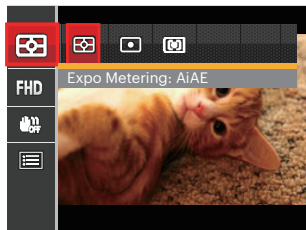
Use this setting to select the “target” size of the camera’s field of view to be metered.



-  **AiAE (Artificial Intelligence AE):** Evaluates the light intensity at multiple points in the frame and automatically determines the best value for the light meter.
-  **Spot:** For metering the block displayed in the center of the screen.
-  **Center:** For metering the object in the center of the screen.

## Movie Size

Set the image resolution used during video recording.

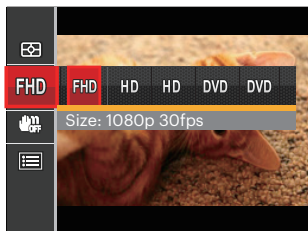



- **FHD** Size: 1080p 30fps
- **HD** Size: 720p 60fps
- **HD** Size: 720p 30fps
- **DVD** Size: 640x480 30fps
- **DVD** Size: High Speed Movie

The speed requirements for reading and writing high image pixel images to SD card are as follows:

No.	Image Pixel	Frame	Recommendation	Recording time (4GB) About
1	1920x1080 *	30	Class 6	30 minutes
2	1280x720 *	60	Class 6	32 minutes
3	1280x720 *	30	Class 4	59 minutes
4	640x480	30	Class 4	106 minutes
5	640x480	120	Class 6	54 minutes

 \* The longest recording time is 29 minutes at one time.

 When recording in higher pixel resolutions for extended periods of time, this can cause the camera to generate heat. This is not a camera malfunction.

 When the video format is set as 640x480 (120fps), shooting time is 30 seconds, playback time is 2 minutes.

 Sound recording is disabled when 640x480 120fps is chosen.

## OIS (Optical Image Stabilization)

This mode can help reduce photo blur caused by unsteady hands and low light.

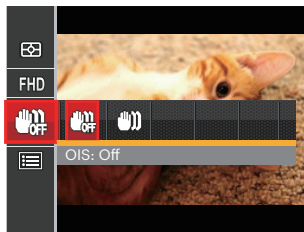

-  OIS: Off
-  OIS: On







 Use this image stabilization mode in dark environments.

 Shooting in a windy or unstable environment (such as a moving vehicle) may cause blurry images.









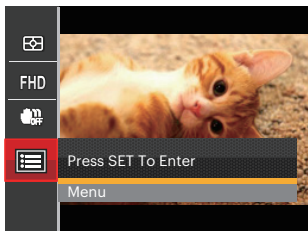

 It is recommended to turn off OIS when using a tripod.

## Movie Setting Menu

Mode: 

1. Rotate the Mode Dial and select  to enter the video recording screen.
2. Press the  button, press the [**▲AF**] / [**▼**  ] button to select , and press the  button to enter the Movie Setting menu.



3. Press the [**▲AF**] / [**▼**  ] button to select , and press the  / [**▶** ] button to enter the menu.
4. Select the item to be set and press the  / [**▶** ] button to enter the menu.
5. Press the [**▲AF**] / [**▼**  ] button to select an option and press the  button to confirm.



## Digital Zoom

Turn the Digital Zoom on or off.

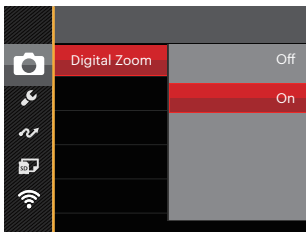





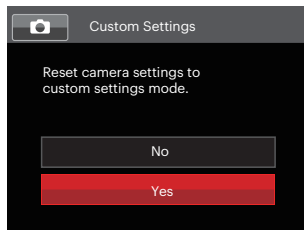







## Custom Settings

Custom Settings stores the current movie mode and its parameters. The stored mode and parameters can be retrieved directly in **CS** mode.



## Playback Menu

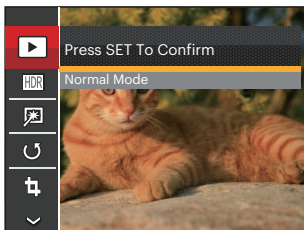

Mode: 

1. Press the  button to display the playback screen and press the  button to enter the menu.
2. Press the [AF] / [  ] button to select the item to be set and press the  button to enter.
3. Press the [ ] / [ ] button to select an option and press the  button to confirm.





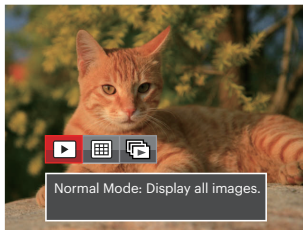

Refer to the following pages for more details about each setting.

## Playback Mode

Select , and press the  button to enter the settings screen:



-  Normal Mode:  
Display all images.
  -  Date Mode:  
Arranged by date.
  -  Cont. Photo Mode:  
Arranged by Cont. Photo Group.
-  The Date Folder is displayed in date order based on camera's Date/Time Settings.
-  If there is no Continuous Shot image file in memory, Continuous Shot Playback mode cannot be enabled.

## HDR (High Dynamic Range)

With the HDR function, pictures that are overexposed may be corrected to optimize the highlights and lowlights captured to more accurately represent the actual scene.

Select **HDR**, and press the **(SET)** button to enter the settings screen:

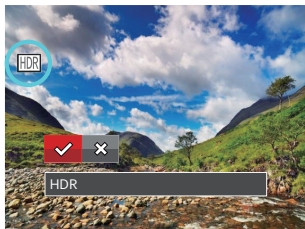

- HDR
- Cancel

 After using the HDR function, the image will be saved as a new file and the original file is still stored in the memory.

## Touch-Up

The playback beauty feature allows for beautification using three individual effects.

Select , and press the **(SET)** button to enter the settings screen:





- Red-Eye Reduction
- Skin Soften
- Eye Brightening
- Eye Enlargement
- Cancel

 Using the Face Beautifier Mode allows you to select from one, two, or all three effects combined.

## Rotate

You can use this setting to change the orientation of the picture.

Select , and press the  button to enter the settings screen:

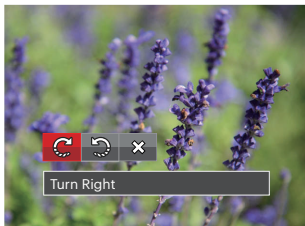



-  Turn Right
-  Turn Left
-  Cancel

 Videos and panoramic pictures cannot be rotated.



 The rotated picture file will replace the original photo.

## Resize

This setting allows you to resize a picture to a particular resolution and saves it as a new picture.

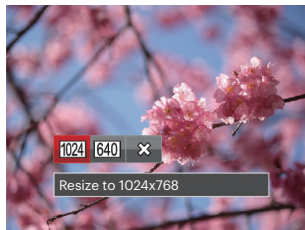
Select , and press the  button to enter the settings screen:



-  Resize to 1024x768
-  Resize to 640x480
-  Cancel

 This function can only be used to downsize photos to a lower resolution.

 Sizes of photos taken in panorama mode or rotated cannot be adjusted.







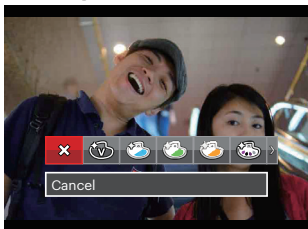











## Color

This setting allows you to change the picture color effect. The file is saved as a new photo and stored in memory together with the original photo.

Press the  button to enter the settings screen:

















There are 19 options available:









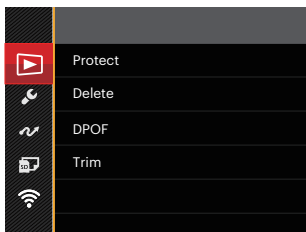

 Cancel	 Sepia	 Vignetting
 Vivid	 Partial Color-Red	 Salon
 Japan Style (8M)	 Partial Color-Blue	 Fish Eye
 Italian Style (8M)	 Partial Color-Yellow	 Reflection
 French Style (8M)	 Partial Color-Green	 4 Grids - Stylish (2M)
 Punk (4M)	 Negative (8M)	
 Black and White	 Dreamy	

## Playback Settings Menu

Mode: 

1. Press the  button to show the playback screen, press the  button, press the [**▲AF**] / [  ] button to select , and press the  button to enter the menu.
2. Press the [**▲AF**] / [  ] button to select , and press the  / [ ] button to enter the menu.



3. Press the [**▲AF**] / [  ] button to select the item to be set and press the  / [ ] button to enter the menu.
4. Press the [**▲AF**] / [  ] button to select an option and press the  button to confirm.

Refer to the following pages for more details about each setting.

## Protect

To prevent any pictures or videos from being accidentally erased, use this setting to lock one or all of the files.

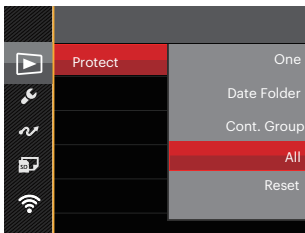

There are 5 options available:

- **One:** Lock the selected photo or video if it is unprotected; unlock the selected photo or video if it is protected.
- **Date Folder:** Protect all photos in the Date Folder.
- **Cont. Group:** Protect all photos in the Cont. Photo Folder.
- **All:** Lock all photos or videos.
- **Reset:** Unlock all photos or videos.

## Delete

You can delete one or all photo/video files.

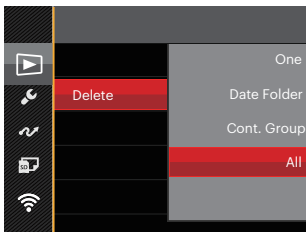

There are 4 options available:

- One: Delete one photo or video.
- Date Folder: Delete all photos in the Date Folder.
- Cont. Group: Delete all photos in the Cont. Photo Folder.
- All: Delete all photos or videos



The “” indicator means a file is protected. File protection must be removed first before a file can be deleted.



Deleting files will cause DPOF settings to be reset.





When one photo in the Cont. Photo and Date Folders is protected, it will be kept but any other photos will be deleted.



## DPOF (Digital Print Order Format)

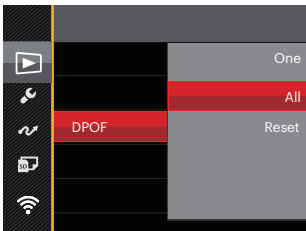



The DPOF feature allows you to compile and select a group of pictures that you would like to print and will save your selection on the memory card so that you can use the SD memory card to print without having to individually specify the photos you want to print.





 The printer that supports DPOF is needed for printing.

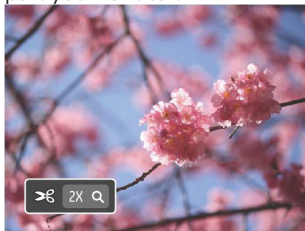

## Trim

The Trim Setting allows you to crop photos and save them as new pictures.

1. Select [Yes] to confirm trim. Rotate the zoom lever to select the aspect ratio and press the [**▲AF**] / [**▼**  ] / [**◀** ] / [**▶** ] buttons to adjust the part you want to trim.



2. Press the  button and the [Save change?] prompt appears. Select [**✓**] to change and save the picture. Select [**✗**] to cancel changes and return to the trim prompt screen.

-  The image cannot be clipped/trimmed again once it has been clipped to 640X480.
-  A trimmed picture cannot be trimmed again.

## General Settings Menu

Mode: PSAM SCN CS

1. Press the button in any mode, press the [AF]/[ ] button to select , and press the button to enter the menu.
2. Press the [AF]/[ ] button to select , and press the /[] button to enter the menu.

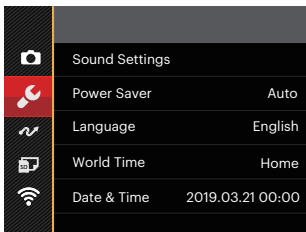

3. Press the [AF]/[ ] button to select the item to be set and press the /[] button to enter the menu.
4. Press the [AF]/[ ] button to select an option and press the button to confirm.

Refer to the following pages for more details about each setting.

## Sound Settings

With this setting you may adjust the sound volume.

Press the [◀🔊] / [▶🔊] button to adjust the volume and press the (SET) button to confirm your setting.

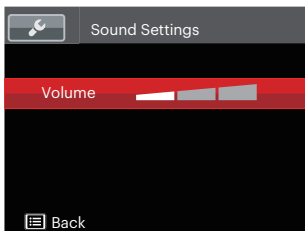

## Power Saver

This setting allows you to save power and get the maximum possible running time for your camera's batteries. It turns the LCD and camera off automatically after a certain period of inactivity.

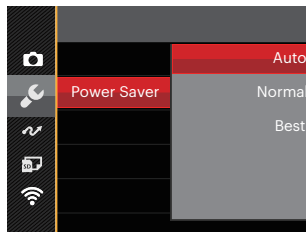

- Auto
- Normal
- Best

Power Saver	LCD power off time	Turn off time
Auto	3 min	5 min
Normal	1 min	3 min
Best	30 sec	1 min

## Language

Refer to the “Reset your language” section on page 25.

## Zone

The Zone setting is a useful function for your overseas trips. This feature enables you to display the local time on the LCD while you are abroad.

1. Press the [▲AF] / [▼🗑️🕒] button to select the departure place (🏠) and destination (🌐) fields.
2. Press the [◀🌸] / [▶🔌] button to select a city located in the same time zone as that of the field. Press the (SET) button to confirm settings.



## Date/Time

Refer to the “Reset Date/Time” section on page 26.

## LCD Brightness

Use this setting to adjust the brightness of your LCD.

Press the [▲AF] / [▼🗑️🕒] button to adjust the brightness of screen and press the (SET) button to confirm.

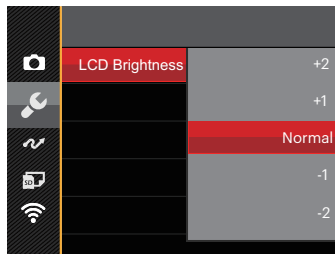

## File Settings

Mode: PS CS

1. Press the button, press the [] / [ ] button to select and press the button to enter the menu.
2. Press the [] / [ ] button to select and press the / [ ] button to enter the menu.
3. Press the [] / [ ] button to select the item to be set and press the / [ ] button to enter the menu.

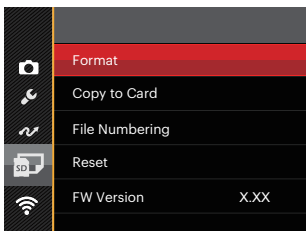



4. Press the [] / [ ] button to select an option and press the button to confirm.

Refer to the following pages for more details about each setting.

## Format

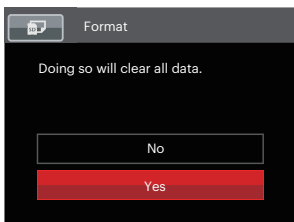
Please note: formatting enables you to delete all contents in the memory card and built-in memory, including protected photo and movie files.



-  If you select [Yes] the camera will format its memory.
-  If there is no memory card in the camera, the built-in memory will be formatted; if there is a memory card, only the card will be formatted.

## Copy to Card

Use this setting to copy the files stored in the built-in memory to a memory card.

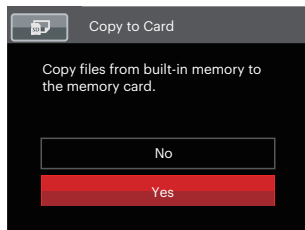

-  If there is no card available in the camera, this function will not be displayed.

## File Numbering

After you take a picture or video clip, the camera will save it with a sequential number. You can use this to reset the file numbering to 1.

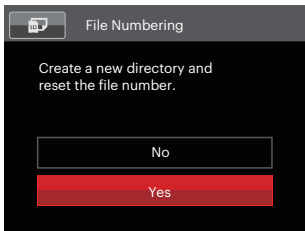

## Reset

Use this setting to restore the camera to its original default settings.

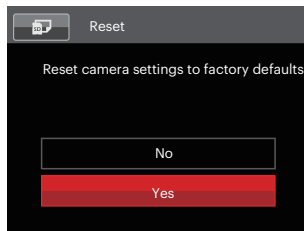

## FW Version

Use this setting to view the current camera firmware version.

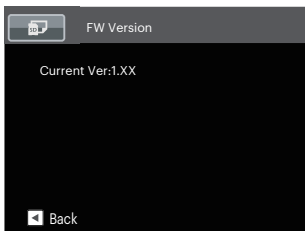

When there is a new firmware version in the memory card, select [Yes] to update.

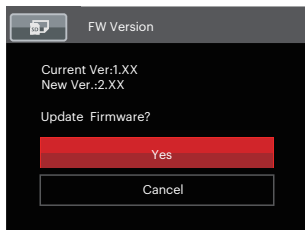

## NEW CAMERA OWNER / IMPORTANT INFORMATION

Thank you for purchasing your new **KODAK PIXPRO AZ528 Astro Zoom** camera. In an effort to provide you with the most up to date benefits and features of the AZ528, **we strongly encourage you to register your new camera on our website:**

**<https://kodakpixpro.com/support/product-registration>**

Doing so will keep you informed of important updates, including firmware, features and other important information that pertain to the AZ528. Your information is always kept secure, is encrypted and is never sold, shared or used for any purposes other than for AZ528 camera specific notifications, unless you opt-in to receive other types of communications during the registration process.



# CONNECTION SETTINGS

Mode: PS AM CS

1. Press the button, press the [AF]/[ ] button to select and press the button to enter the menu.
2. Press the [AF]/[ ] button to select and press the /[ ] button to enter the menu.
3. Press the [AF]/[ ] button to select the item to be set and press the /[ ] button to enter the menu.

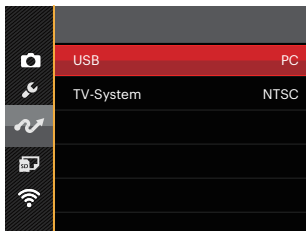

4. Press the [AF]/[ ] button to select an option and press the button to confirm.

Refer to the following pages for more details about each setting.

## Connecting to a Computer

You can use the Micro USB cable to connect the camera and copy (transmit) photos to a computer, printer or other device.

### Setting the USB Mode

The camera's Micro USB port can be set to connect with either a computer or a printer. The following steps will allow you to ensure that the camera is correctly configured to connect with a PC.

1. Press the [▲AF] / [▼🗑️🔄] button to select [USB] and press the (SET) / [▶⚡] button to enter the menu.
2. Press the [▲AF] / [▼🗑️🔄] button to select [PC] and press the (SET) button to confirm.

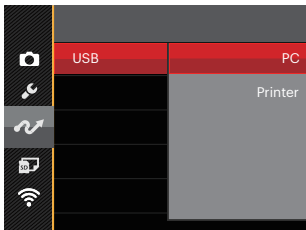

## Transferring files to your computer

The computer will automatically detect the camera as a removable drive. Double-click the My Computer icon on the desktop to locate the removable drive and to copy folders and files in the drive to a directory on your PC as you would copy any typical folder or file.

Follow the steps below to connect the camera to a computer.

1. Make sure the computer is turned on.
2. Connect one end of the supplied Micro USB cable to the Micro USB port on your camera.
3. Connect the other end of the cable to an available USB port on your computer.

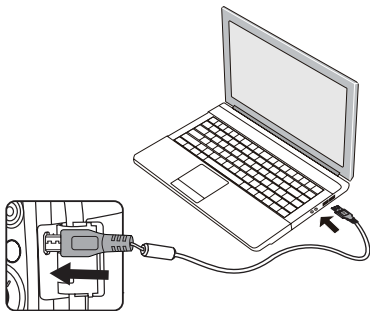

4. After the transmission is complete, disconnect the Micro USB cable according to the instructions specifying how to safely remove USB devices.

## Connecting to a PictBridge Compatible Printer

PictBridge technology allows printing of the photos saved in the memory card by the printer.

To find out if a printer is PictBridge compatible, simply look for the PictBridge logo on the packaging or check the owner's manual for specifications. With the PictBridge function on your camera, you can print the captured photos directly to a PictBridge compatible printer using the supplied Micro USB cable, without the need for a PC.

### Setting the USB Mode

The camera's Micro USB port can be set to connect with either a PC or a Printer; the following steps will ensure that the camera is correctly configured to connect with a Printer.

1. Press the [▲AF] / [▼🗑️🔄] button to select [USB] and press the (SET) / [▶⚡] button to enter the menu.
2. Press the [▲AF] / [▼🗑️🔄] button to select [Printer] and press the (SET) button to confirm.

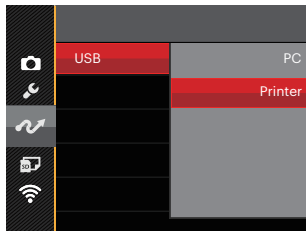

- ⓘ After the camera is reset, it will switch to PC mode automatically from USB mode.
- ⓘ See “PictBridge” section on page 105.

## Connecting to your Printer

1. Make sure the printer is turned on.
2. Connect one end of the supplied Micro USB cable to the Micro USB port on your camera.
3. Connect the other end of the cable to the USB port on the printer.

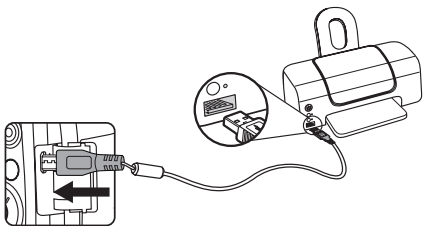

If the camera is not connected to a PictBridge compatible printer, the following error message will appear on the LCD.

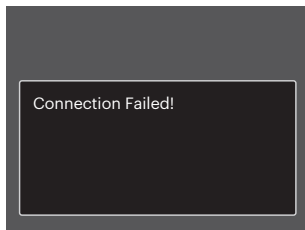

The error message above will also appear if the USB mode is set incorrectly, in which case you should disconnect the Micro USB cable, check the USB mode settings, ensure that the printer is turned on, and then try connecting the Micro USB cable again.

## Using the PictBridge Menu

After setting the USB mode to Printer, the PictBridge menu will appear.

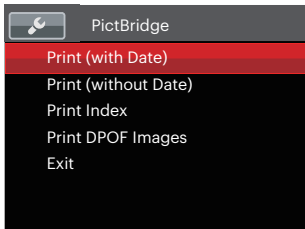

Press the [▲AF] / [▼🗑️🔄] button to select a menu item and press the (SET) / [▶⚡] button to enter the item.

Refer to the following sections for more detailed information on each setting.

### Print (with Date)

If you have set the date and time on your camera, the date and time will be recorded and saved with each photo you take.

1. In the PictBridge menu, select [Print (with Date)] and the screen as shown below appears.

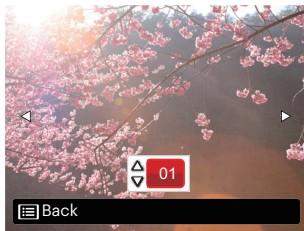

2. Press the [◀🌸] / [▶⚡] button to select a photo to be printed.

3. Press the [▲AF] / [▼🗑️🕒] button to select the number of copies for the currently displayed photo.
4. Press the (SET) button and the following screen will appear.

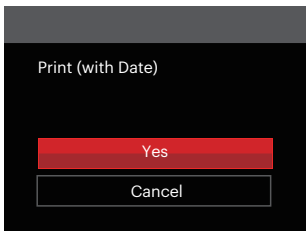

5. Select [Yes] and press the (SET) button to confirm printing; select [Cancel] and press the (SET) button to cancel printing.

## Print (without Date)

Use this setting to print the photos without dates on them.

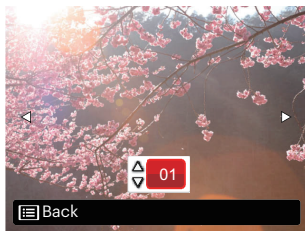

1. In the PictBridge menu, select [Print (without Date)] and the screen as shown below appears.

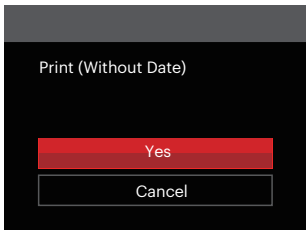

2. Press the [◀🌸] / [▶⚡] button to select a photo to be printed.
3. Press the [▲AF] / [▼🗑️🕒] button to select the number of copies for the currently displayed photo.

4. Press the  button and the following screen will appear.





5. Select [Yes] and press the  button to confirm printing; select [Cancel] and press the  button to cancel printing.

## Print Index

You can print all photos in the camera via this function.

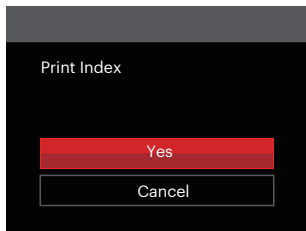
1. In the PictBridge menu, select [Print Index] and the screen as shown below appears.



2. Select [Yes] and press the  button to confirm printing; select [Cancel] and press the  button to cancel printing.



## Print DPOF Images

To use DPOF printing, you must select your photos for printing using the DPOF settings beforehand. See “DPOF” section on page 92.

1. In the PictBridge menu, select [Print DPOF Images] and the screen as shown below appears.

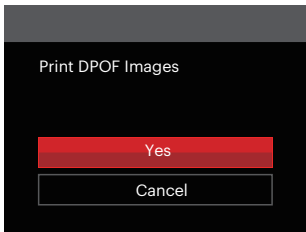

2. Select [Yes] and press the **(SET)** button to confirm printing; select [Cancel] and press the **(SET)** button to cancel printing.

## Exit

Select [Exit] to exit the PictBridge menu. At this time, the message [Remove USB Cable!] appears on the screen.

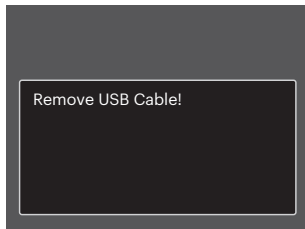

Disconnect the Micro USB cable from the camera and printer.

## Video System

You can use the AV cable (which should be purchased separately) to connect the camera and the television for setting up the video output. Connect one end of the AV cable to Micro USB/AV port of the camera, and connect the other end to AV-OUT port of the television. To adjust the format of the video output system according to your requirements:

1. Press the [▲AF] / [▼🗑️🔄] button to select [TV-System] and press the (SET) / [▶⚡] button to enter the menu.
2. Press the [▲AF] / [▼🗑️🔄] button to select [NTSC] or [PAL] and press the (SET) button to confirm.

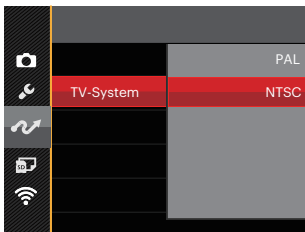

NTSC: English, Chinese (Traditional), Japanese, Korean, Vietnamese

PAL: German, Spanish, Italian, Chinese (Simplified), Portuguese, Swedish, Danish, Finnish, Indonesia, Norwegian, Dutch, Turkish, Polish, Thai, Croatian, Czech, Arabic, Hindi, Hungarian, Greek, Russian, French

# APPENDICES

## Product Specifications



Design and specifications are subject to change without notice.

Image Sensor	Type	1/2.3"BSI CMOS
	Effective Pixels	16.35 Megapixels
	Total Pixels	16.76 Megapixels
Lens	Focal Length	4.3mm (Wide) – 223.6mm (Tele)
	35mm film equivalent	24mm (Wide) – 1248mm (Tele)
	F number	F2.8 (Wide) ~ F5.6 (Tele)
	Lens Construction	13 groups 15 elements
	Optical Zoom	52x
	Optical Zoom	Normal: (Wide) 60cm ~ ∞, (Tele) 300cm ~ ∞; Macro: 1cm ~ ∞ (Wide Only)
Autofocus System		TTL Autofocus
Anti-Handshake		Optical Image Stabilization
Digital Zoom		4x Digital Zoom (Combined Zoom: 208x)

Number of Recording Pixels	Still Image	(4:3) 16MP: 4608 X 3456 10MP: 3648 X 2736 5MP: 2592 X 1944 3MP: 2048 X 1536 0.3MP: 640 X 480	(3:2) 14MP: 4608 X 3072	(16:9) 12MP: 4608 X 2592 2MP: 1920 X 1080
	Movie	1920 X 1080 (30fps), 1280 X 720 (60fps/30fps), 640 X 480 (30fps), High-Speed Movie: 640 X 480 (120fps)		
Image Compression		Best, Fine, Normal		
DCF, DPOF (Ver1.1) Support		Yes		
File Format	Still Image	Exif 2.3 (JPEG)		
	Movie	MOV [Image: H.264; Audio: Linear PCM (Stereo)]		
Shooting Modes		Auto Mode, Program AE, Shutter priority, Aperture priority, Manual Mode, Face Beautifier, Wi-Fi Mode, Scene Mode, Movie Mode, Custom Settings		
Scene Mode		Handheld Night, Pet Mode, Sunset, Fireworks, Multi Exposure, Sport, Night Portrait, Landscape, Portrait, Snow, Children, Party, Panorama Mode		
Detection Features		Face, Smile, Blink, Cat, Dog		
Photo Touch-up		Red-Eye Reduction, Skin Soften, Eye Brightening, Eye Enlargement		
HDR		Yes		

Scan Panorama	Up to 360°	
LCD	3.0 inch (460k Pixels)	
Image Auto Rotation	Yes	
ISO Sensitivity	Auto, ISO100/200/400/800/1600/3200	
AF Method	Single AF, Multi-AF (TTL 25-point), Object Tracking , Face-Detection	
Exposure Metering Method	Artificial Intelligence AE (AiAE), Center-Weighted Average, Spot (Fixed to Center of Frame), Face AE	
Exposure Control Method	Program AE (AE-Lock Available), Shutter Prior AE, Aperture Prior AE	
Exposure Compensation	±3 EV in 1/3 Step Increments	
Shutter Speed	1/2000 ~ 30 Seconds	
Continuous Shot	Yes	
Playback Modes	Single, Index (9/16 Thumbnails), Slide Show, Date, Continuous Shooting, Zoom (Approx. X 2 ~ X 8)	
White Balance Control	AWB, Daylight, Cloudy, Fluorescent, Fluorescent CWF, Incandescent, Manual WB, Color Temp. (1900K ~ 10000K)	
Flash	Flash Method	Pop-up (Manual)
	Flash Modes	Force Off, Flash Auto, Fill Flash, Red-Eye Reduction, Slow Sync., Slow Sync.+Red-Eye Reduction

Recording Media	Internal Memory: Approx. 8MB
	SD/SDHC Card (Up to 32GB Support) [MMC Card Not Supported]
Multi-Language Support	27 Languages
Jacks	AV-OUT/USB 2.0 (Micro 5 pin USB)
Wi-Fi	Yes (802.11b/g/n)
Remote Viewfinder	Yes (via smart device)
Power	Rechargeable Li-ion Battery LB-060, 3.7V 1100mAh, In-Camera Charging
Shooting Capability (Battery Performance)	Approx. 240 Shots (Based on CIPA Standards)
Operation Environment	Temperature: 0 ~ 40°C, Humidity: 0 ~ 90%
Dimensions (W X H X D)	Approx. 121.3 X 85.8 X 97.5mm (Based on CIPA Standards)
Weight	Approx. 508g (Body only)

## Prompts and Warning Messages

Message	Description	Action
Warning! Battery exhausted.	Camera battery is depleted. It is a warning indicating that the camera is going to shut off.	Charge battery or replace with a charged battery.
Lens obstruction, Re-start Camera.	The lens is jammed or some foreign object is preventing the lens from functioning properly.	Turn off the camera and restart it to reset the lens.
Suggest using tripod.	When continuous exposure is enabled, this prompt message is displayed when the photo shooting screen is displayed for the first time.	The message will disappear after 2 seconds.
Built-in memory error!	An error has occurred in the built in memory.	Try shutting off the camera and turning it on again.
Improper alignment. Please try again.	The offset is too big for panorama shooting.	Keep the camera steady while shooting to maintain alignment.
Warning! Do not turn off your camera during update!	The message appears during the firmware update process.	The message disappears after the camera update and restart.

<b>Message</b>	<b>Description</b>	<b>Action</b>
Remove USB Cable!	Indicates that you can disconnect the Micro USB cable.	The message disappears after you disconnect the Micro USB cable.
Connection Failed!	Failure to connect to PC, printer, or TV-system.	Remove cable, reinsert cable, and retry connection.
Write Protect !	The SD card is locked.	Turn off camera and remove SD card. Slide tab on the side of card to unlock.
Card Full !	The memory of the SD card is full.	Either delete photos or videos to create room on the card, or replace with another card that has available memory.
Memory Full !	The camera's internal memory is full.	Erase files or insert a memory card that has available memory.



<b>Message</b>	<b>Description</b>	<b>Action</b>
Card Error !	The card cannot be recognized after being formatted.	Check that the SD card is compatible with the camera.
Card is not formatted.	An error has occurred with the memory card.	Format the memory card. This will erase all data on the card; be sure to copy the data from the card onto another device if you wish to keep it.
Slow access	When a card lower than Class 4 is recording movie above HD, the writing speed will be slower and the recording will not continue.	Replace SD card with a Class 4 or higher card.
Cannot write to SD card.	The camera cannot write to the SD card.	Turn off the camera. Remove and reinsert the SD card and turn the camera on to try again. Check if the SD card is in a locked position, or if the memory is full.
No Red-Eye Detected!	No red-eye is detected when selecting Red-Eye Removal in Playback Touch-up.	The message will disappear after 2 seconds and return to the touch-up menu.
This image cannot be edited.	The file format does not support editing or the edited file cannot be edited again.	The message will disappear after 2 seconds and return to the original image.

<b>Message</b>	<b>Description</b>	<b>Action</b>
Exceeded maximum folder number.	The folder number in the card exceeds the maximum folder number (999).	Copy the data to your PC, and format the memory card.
Too many pictures for fast processing.	During Playback by Date, the images exceed specifications so it is not possible to play by date.	The message will disappear after 2 seconds and return to Thumbnail 3x3 mode.
Unable to recognize files.	The format of the file viewed is not supported or the file is damaged and cannot be recognized properly.	This message will only disappear after the file is deleted.
No Picture!	When the play button is pushed and there are no files on memory card or in camera.	The message will disappear after 2 seconds and return to previous screen.
No continuous group file.	When the camera switches from Playback Mode to Cont. Playback Mode, and there are no continuous group files, this message will be displayed.	The message will disappear after 2 seconds and return to Thumbnail 3x3 mode.
Protected! Undeletable!	The file is protected and cannot be deleted.	Unlocked file under "Protect", and make sure SD card is unlocked.

## Troubleshooting

<b>Problem</b>	<b>Possible Causes</b>	<b>Solution</b>
Camera does not turn on	<ul style="list-style-type: none"><li>■ The battery has been depleted.</li><li>■ The battery is not inserted correctly.</li></ul>	<ul style="list-style-type: none"><li>■ Recharge the battery.</li><li>■ Correctly reinstall the battery.</li></ul>
Camera turns off suddenly during operation	<ul style="list-style-type: none"><li>■ The batteries have been depleted.</li></ul>	<ul style="list-style-type: none"><li>■ Recharge the battery.</li><li>■ Make sure the camera is actually shutting off and not entering Power Save Mode, where the LCD will turn off after the camera has been idle for a period of time.</li></ul>
The picture is blurry	<ul style="list-style-type: none"><li>■ Camera shakes while taking a picture.</li></ul>	<ul style="list-style-type: none"><li>■ Turn on OIS feature.</li><li>■ Please use tripod for high magnification (above 15X) optical zoom. If you are holding the camera, be sure to use both hands.</li></ul>
Images and video files cannot be saved	<ul style="list-style-type: none"><li>■ The SD memory card is full.</li><li>■ The memory card is locked.</li></ul>	<ul style="list-style-type: none"><li>■ Use another memory card or delete unnecessary files.</li><li>■ Unlock the memory card.</li></ul>

Problem	Possible Causes	Solution
Images will not print from the connected printer	<ul style="list-style-type: none"> <li>■ The camera is not connected to the printer correctly.</li> <li>■ The printer is not PictBridge compatible.</li> <li>■ The printer is out of paper or ink.</li> <li>■ The printer paper is jammed.</li> </ul>	<ul style="list-style-type: none"> <li>■ Check the connection between the camera and printer.</li> <li>■ Use a PictBridge compatible printer.</li> <li>■ Load paper into the printer or replace the ink cartridge in the printer.</li> <li>■ Remove the jammed paper.</li> </ul>
Saving data to memory card is slow	<ul style="list-style-type: none"> <li>■ Using a memory card below Class 4 may result in slower recording times.</li> </ul>	<ul style="list-style-type: none"> <li>■ Use a memory card with write Class 4 or higher than 4 to improve performance.</li> </ul>
Cannot write to the memory card	<ul style="list-style-type: none"> <li>■ The SD memory card has been locked.</li> </ul>	<ul style="list-style-type: none"> <li>■ Release the write lock of the memory card or replace with another card.</li> </ul>
Too many movies to process	<ul style="list-style-type: none"> <li>■ The number of pictures or folders in the memory card exceed the specifications, so the playback of data folder can not be displayed.</li> </ul>	<ul style="list-style-type: none"> <li>■ Delete unwanted files.</li> </ul>
The flash icon  appears on the LCD	<ul style="list-style-type: none"> <li>■ Current shooting environment requires flash.</li> </ul>	<ul style="list-style-type: none"> <li>■ Turn on flash.</li> </ul>

When shooting with stacked filters attached, the corners of the photo may turn dark (Vignetting effect) because the filter holder blocks light from reaching the camera image sensor; especially, at wide angle zoom control settings. Please take test shots and review the results when using stacked filters.

If you choose to change the factory assigned, random Wi-Fi® password on your AZ528 camera, please be sure to update and enter the new randomly assigned password on your smart device. Some smart devices will automatically remember and save any previously entered Wi-Fi® password. Be sure to clear the old password on your smart device manually before attempting to connect the AZ528's Wi-Fi® to your device. (Depending upon your smart device make and model, operation may vary, so please refer to your smart device user manual and instructions.

### iOS™ Example

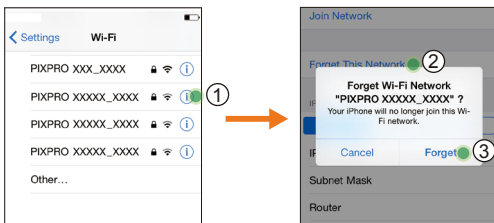

### Android™ Example

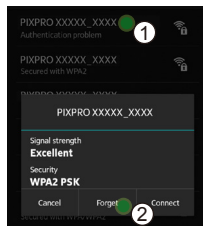

## Memory Card Compatibility

Refer to the chart below for compatible types of SD cards (√: Compatible X: Not Compatible)

	micro SD	micro SDHC	micro SDXC	Conversion adapter to SD card	SD	SDHC	SDXC
Format	FAT12, 16	FAT32	exFAT	-	FAT12, 16	FAT32	exFAT
Capacity	Up to 2GB	4-32GB	64GB-2TB	-	Up to 2GB	4-32GB	64GB-2TB
Compatibility	X	X	X	√	√	√	X

It indicates that the writing speed class will be displayed on the memory card.

Use a memory card with the appropriate writing speed for the video recording mode to be recorded. (O: Recommended X: Not recommended)

	Speed Class	UHS Speed Class	Video Speed Class	Video Recording			
				4K	FHD	HD	VGA
90MB/sec			V90	O	O	O	O
60MB/sec		UHS-III	V60	O	O	O	O
30MB/sec		UHS-I	V30	O	O	O	O
10MB/sec	Class 10		V10	O	O	O	O
6MB/sec	Class 6		V6	X	O	O	O
4MB/sec	Class 4			X	X	X	O
2MB/sec	Class 2			X	X	X	O

© 2022 JK Imaging Ltd. All Rights Reserved.

The Kodak and Kodachrome, Kodacolor and Ektachrome trademarks, logo and trade dress are used under license from Eastman Kodak Company.

All other logos, products or company names that are referred to in this document are trade names, trademarks or registered trademarks of their respective owners and holders. The owners and holders are not affiliated with JK Imaging Ltd., our products or our website.

**JK Imaging Ltd., 17239 So. Main Street, Gardena, CA 90248 USA**

**kodakpixpro.com**

**Made in Myanmar**

Document No/Sequence: U.DIS.0062.1222.en.06



Ver 6.0