

# KODAK PIXPRO AZ652

DIGITAL CAMERA

User Manual



# BEFORE YOU START

## **Declaration of Conformity**

Responsible Party: JK Imaging Ltd.

Address: JK Imaging Ltd., 17239 So. Main Street, Gardena, CA 90248 USA

Company Website: [kodakpixpro.com](http://kodakpixpro.com)

## **INDUSTRY CANADA**

This device complies with Canadian RSS-247.

This device complies with Industry Canada license-exempt RSS standard (s). Operation is subject to the following two conditions: (1) this device may not cause interference and (2) this device must accept any interference, including interference that may cause undesired operation of the device.

## **Radiation Exposure Statement:**

This product complies with the Canadian portable RF exposure limit set forth for an uncontrolled environment and is safe for intended operation as described in this manual. Additional RF exposure reduction can be achieved if the product can be kept as far as possible from the user body or set the device to lower output power if such function is available.



## For Customers in Europe



This symbol [crossed-out wheel bin WEEE Annex IV] indicates separate collection of electrical waste and electronic equipment in the European countries. Please do not throw the equipment into domestic refuse. Please use the return and collection systems available in your country for proper, safe disposal of this product.



“CE” mark indicates that this product complies with the European requirements for safety, health, environment and customer protection. “CE” marked cameras are intended for sales in Europe.

### Europe – EU Declaration of Conformity

This device complies with the essential requirements of the R&TTE Directive 2014/53/EU. The following test methods have been applied in order to prove presumption of conformity with the essential requirements of the R&TTE Directive 2014/53/EU:

- EN 62368-1:2014

Safety of Information Technology Equipment

- EN 50566:2017

Product standard to demonstrate compliance of radio frequency fields from handheld and body-mounted wireless communication devices used by the general public (30 MHz – 6 GHz)

- EN 62209-2:2010/A1:2019

Human exposure to radio frequency fields from handheld and body-mounted wireless communication devices — Human models, instrumentation, and procedures

Part 2: Procedure to determine the specific absorption rate (SAR) for wireless communication devices used in close proximity to the human body (frequency range of 30 MHz to 6 GHz)

- EN 300 328 V2.2.2 (2019-07)

Electromagnetic compatibility and Radio spectrum Matters (ERM); Wideband transmission systems; Data transmission equipment operating in the 2.4GHz ISM band and using wide band modulation techniques; Harmonized EN covering the essential requirements of article

- EN 301 489-1 V2.2.3 (2019-11)

Electromagnetic compatibility and Radio Spectrum Matters (ERM); Electro Magnetic Compatibility (EMC) standard for radio equipment and services; Part 1: Common technical requirements.

- EN 301 489 -17 V3.2.4 (2020-09)

Electromagnetic compatibility and Radio spectrum Matters (ERM); ElectroMagnetic Compatibility (EMC) standard for radio equipment; Part 17: Specific conditions for Broadband Data Transmission Systems

Hereby, Sintai Optical (Shenzhen) Co., Ltd, declares that this PIXPRO AZ652 is in compliance with the essential requirements and other relevant provisions of Directive 2014/53/EU.

Manufacturer: Sintai Optical (Shenzhen) Co., Ltd

Address: Qiwei Ind Sec, 1st, 2nd, & 3RD Bldg, Lisonglang Village, Gongming Town, Bao'an District, Shenzhen, Guangdong, China



Batteries: Please dispose of used batteries at designated collection centers.



Packaging: Please follow local regulations for the recycling of packaging.

### **For Customers in the U.S.A.**

Federal Communication Commission Interference Statement

This device complies with Part 15 of the FCC Rules. Operation is subject to the following two conditions: (1) This device may not cause harmful interference, and (2) this device must accept any interference received, including interference that may cause undesired operation.

This equipment has been tested and found to comply with the limits for a Class B digital device, pursuant to Part 15 of the FCC Rules. These limits are designed to provide reasonable protection against harmful interference in a residential installation. This equipment generates, uses and can radiate radio frequency energy and, if not installed and used in accordance with the instructions, may cause harmful interference to radio communications. However, there is no guarantee that interference will not occur in a particular installation. If this equipment does cause harmful interference to radio or television reception, which can be determined by turning the equipment off and on, the user is encouraged to try to correct the interference by one of the following measures:

- Reorient or relocate the receiving antenna.
- Increase the separation between the equipment and receiver.
- Connect the equipment into an outlet on a circuit different from that to which the receiver is connected.
- Consult the dealer or an experienced radio/TV technician for help.

FCC Caution: Any changes or modifications not expressly approved by the party responsible for compliance could void the user's authority to operate this equipment.

This transmitter must not be co-located or operating in conjunction with any other antenna or transmitter.

### **Radiation Exposure Statement:**

This product complies with the FCC portable RF exposure limit set forth for an uncontrolled environment and is safe for intended operation as described in this manual. Additional RF exposure reduction can be achieved if the product can be kept as far as possible from the user body or set the device to lower output power if such function is available.

## About this Manual

Thank you for purchasing this KODAK PIXPRO Digital Camera. Please read this manual carefully and keep it in a safe place for future reference.

- JK Imaging Ltd. reserves all rights of this document. No part of this published manual may be reproduced, transmitted, transcribed, stored in a retrieval system or translated into any language or computer language, in any form, by any means, without the prior written permission of JK Imaging Ltd.
- All trademarks mentioned in this manual are used for identification purposes only and are properties of their respective owners and holders.
- This manual provides you with instructions on how to use your new KODAK PIXPRO Digital Camera. Every effort has been made to ensure that the contents of this manual are accurate; however JK Imaging reserves the right to make changes without notice.
- Throughout this manual, the following symbols are used to help you locate information quickly and easily:



Indicates useful information.

- The following symbols may be used throughout this manual to facilitate your understanding of how to operate the camera:  
[Item properties] : The optional properties in the camera interface are indicated by the [ ] symbol.

# SAFETY NOTES

## Safety Notes for this Camera

- Do not drop the camera or allow it to hit solid objects.
- Do not attempt to disassemble or repair the camera.
- Do not use or store the camera in dusty places or on a beach to help prevent dust or sand from entering the camera, causing possible damage.
- Do not use or store the camera in a hot environment or in direct sunlight.
- Do not use or store the camera near powerful magnetic fields, such as a magnet or transformer.
- Avoid touching the lens of the camera.
- Do not expose the camera to direct sunlight for a long period of time.
- To prevent the camera from being damaged by moisture, do not use or store the camera in very humid environments, such as in rain or near bodies of water.
- If water accidentally comes in contact with the camera, turn the camera off immediately, remove the battery and the memory card and dry it completely within 24 hours.
- When you take the camera from a cold environment to a warmer environment, condensation may occur. Please wait for a reasonable period of time before you turn the camera on.
- Before you remove the battery and memory card, the camera should be turned off.
- When you clean the body of the camera, do not use abrasive, alcohol-based or organic cleansers or solvents.
- Use a professional lens cleaning cloth and appropriate cleaner to wipe and clean the lens.
- Download your photos and remove the memory card when you are going to store the camera for long periods of time.
- If this camera is not in use for a long period of time, please keep it in a dry and clean storage location.
- Our company will not pay compensation for any failure of playback including: pictures or videos damaged or unrecoverable by improper operation.

## Safety Notes for Battery

- Please use a battery that is the same type as the one included.
- Please use the attached charger to charge the battery.
- If battery fluid leaks inside the camera, contact our customer service department immediately. If battery fluid leaks onto your skin, rinse your skin immediately with clean water and seek immediate medical attention.
- Disposal of used batteries should be carried out in accordance with your local (national or regional) regulations.
- To prevent the battery from being damaged, do not drop the battery or allow it to hit solid objects or to be scratched by foreign objects.
- Do not let the battery come in contact with metal objects (including coins) to avoid short circuiting, discharging, excessive heat or possible leakage.
- Do not attempt to disassemble the battery.
- Do not expose the battery to water. Always keep the battery contacts dry.
- Do not heat the battery or throw it into a fire to avoid a possible explosion.
- Do not store the battery in a hot environment or in direct sunlight.
- If the battery overheats during charging or use, stop charging or use immediately. Turn off the product, remove the battery carefully, and wait until it cools down.
- When the camera is stored for a long period of time, remove the battery and keep it in a safe, dry place that is not accessible to infants and children.
- In colder environments, the performance of the battery could be noticeably reduced.
- When you install the battery, align the battery markings according to the positive and negative markings inside the camera battery compartment. Never force the battery into the battery compartment.

## Safety Notes for Memory Card

- We highly suggest buying only well-known, name brand memory cards to ensure peak performance and reliability.
- Format the memory card using the camera before you use it or insert a new one.
- Do not drop the memory card or allow it to hit solid objects to avoid damaging it.
- Do not attempt to disassemble or repair the memory card.
- Do not expose the memory card to water. Always keep it dry.
- Do not remove the memory card when the camera is turned on. Otherwise, the memory card and photo/video files could be permanently damaged.
- Do not directly edit the data on the memory card. Copy the data to your computer before you edit files.
- When the camera is stored for long periods of time, be sure to download your photos and remove the memory card. Store the memory card in a dry environment.
- Do not modify the name of the files or folders of the memory card using your computer. Modifying the file names may cause the files to not be recognized on the camera or a possible permanent error may occur.
- A photo taken with the camera will be stored in the folder that is automatically generated on the memory card. Do not store photos that are not taken using this camera in these folders as the pictures cannot be recognized during playback.
- When you insert the memory card, make sure the notch of the card matches the markings on the top of the camera card slot.

## Other Safety Notes

- Do not disconnect the power or turn the camera off during the update process. Doing so may cause incorrect data to be written and the camera may not power on later.
- Do not hang the neck strap of the camera around the neck of a child.
- When using your camera on an airplane, observe the relevant rules specified by the airline and FAA regulations.
- Due to the limitations of manufacturing technology, the LCD may have a few dead or bright pixels. These pixels do not affect the quality or performance of the camera, photos or video.
- Do not expose the camera's LCD to water. In a humid environment, only wipe it with a soft, dry, cleaning cloth.
- If the LCD is damaged and the liquid crystal comes into contact with your skin, wipe your skin with a dry cloth immediately and rinse it with clean water. If liquid crystal comes into contact with your eyes, wash them with clean water at least for 15 minutes and seek immediate medical attention. If you accidentally swallow liquid crystal, rinse your mouth immediately and seek medical attention.

## Trademark Information

- The terms HDMI, HDMI High-Definition Multimedia Interface, HDMI Trade dress and the HDMI Logos are trademarks or registered trademarks of HDMI Licensing Administrator, Inc.





## WARNING

- Altering, tampering or modifying any parts of the AZ652 camera are unauthorized and will void the manufacturer's warranty and "could" void Federal and/or State Compliance.



# CONTENTS

BEFORE YOU START .....	1	Resetting Date/Time .....	26
SAFETY NOTES .....	6	MODE OVERVIEW .....	27
CONTENTS .....	10	LCD Display .....	27
GETTING READY .....	14	Overview of the Screen	
Accessories Included .....	14	Icons in Shooting Mode .....	27
Installing Lens Cap and		Overview of the Screen	
Neck Strap .....	15	Icons in Movie Mode .....	29
Part Names .....	16	Overview of the Screen	
Installing Battery and		Icons in Playback Mode .....	30
Memory Card .....	19	How to Take Pictures .....	31
Charging the Battery .....	21	Using the Mode Dial .....	32
Vari-Angle LCD .....	22	Face Beautifier  .....	35
Turning Camera On and Off .....	23	Wi-Fi® Mode  .....	36
Set your Language, Date/Time		Scene Mode <b>SCN</b> .....	43
after the First Power-On .....	24	Custom Settings ( <b>CS</b> ) .....	49
Set your Language, Date/Time .....	24	BASIC OPERATION .....	51
Resetting your Language .....	25	Using EVF	
		(Electronic View Finder) .....	51

Using the Zoom Function.....	52
Display Setting .....	53
AF Area .....	55
Macro Mode.....	56
Self-Timer Mode .....	57
Flash Mode .....	58
WB (White Balance) Mode .....	60
Continuous Shot Mode .....	62
Exposure Compensation Functions Setting .....	64
EV Adjustment.....	64
ISO Adjustment.....	65
Shutter Speed Adjustment .....	65
Aperture Adjustment .....	66
Using Quick Recording .....	66
“i” Button Function Menu.....	67
Using the Lens Function Ring .....	68
Zoom/AF Mode.....	68







Function Ring (Smart) Mode ....	69
MF(Manual Focus) Mode.....	70

## PLAYBACK ..... 71

Viewing Photos and Videos .....	71
Thumbnail View .....	72
Using Zoom Playback (for still pictures only) .....	73
Continuous Shot Group Playback ..	74
Animation Panorama Play .....	75
Slideshow .....	76
Deleting Photos and Videos.....	77

## USING THE MENUS..... 78

Shooting Menu .....	78
Expo Metering.....	79
OIS (Optical Image Stabilization) ....	79
Beautifier .....	80

Select Scene .....	80	Rotate  .....	93
Shoot Setting1 .....	81	Color  .....	94
Image Size .....	82	HDR  .....	95
Movie Size .....	83	Touch-Up  .....	96
Quality .....	84	Resize  .....	97
MF (Manual Focus) Assist .....	85	Playback Settings .....	97
AF Assist Beam.....	86	Protect .....	98
Digital Zoom.....	86	Delete .....	98
Shoot Setting 2.....	87	DPOF (Digital Print Order Format) .....	99
Date Imprint .....	88	Trim.....	100
Quick Review.....	88	Play Slide Show.....	100
Continuous AF .....	89	General Settings.....	101
Face Detection .....	89	Sound Settings.....	102
Custom Settings .....	90	Power Saver.....	102
Function Ring (Smart).....	91	Language.....	103
Playback Menu .....	92	World Time .....	103
Menu  .....	92	Date & Time.....	103
Display Mode  .....	93		

LCD Brightness.....	103	Print (without Date).....	113
File Settings.....	104	Print Index .....	114
Format .....	105	Print DPOF Images .....	115
Copy to Card.....	106	Exit.....	115
File Numbering.....	106	Video System .....	116
Reset Settings .....	107	Supported HDMI Connections .....	117
Version.....	107	Connecting HDMI-Ready TV... ..	117
<b>CONNECTION SETTINGS ..</b>	<b>108</b>	HDMI CEC Control.....	118
Connecting to a Computer.....	108	Set Eye-Fi SD Card Connection Mode	123
Setting the USB Mode .....	108	<b>APPENDICES .....</b>	<b>124</b>
Transferring Files to your		Product Specifications.....	124
Computer .....	109	Prompts and Warning Messages ..	128
Connecting to a PictBridge		Troubleshooting .....	133
Compatible Printer .....	110		
Setting the USB Mode .....	110		
Connecting to your Printer.....	111		
Using the PictBridge Menu .....	112		
Print (with Date) .....	112		

# GETTING READY

## Accessories Included

Your camera box should contain the camera model you purchased along with the following accessories. If anything is missing or appears to be damaged, please contact your retailer first or our customer service center (Based on sales in different countries or regions, the shape of the AC adapter will vary. Please subject to the actual product will prevail.)

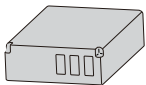

Rechargeable  
Li-ion Battery

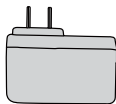

AC Adapter

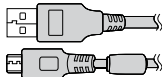

Micro USB Cable



Neck Strap

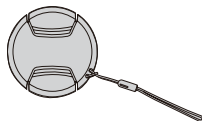

Lens Cap With Strap



Quick Start Guide



Warranty Card



Service Card

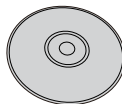

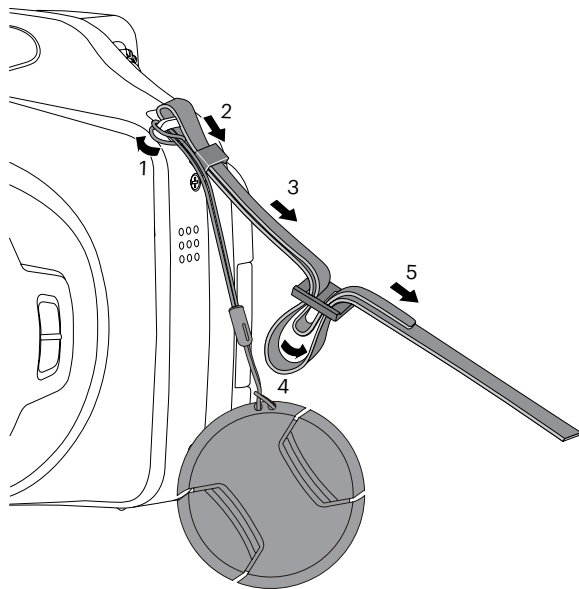

CD-ROM

## Installing Lens Cap and Neck Strap

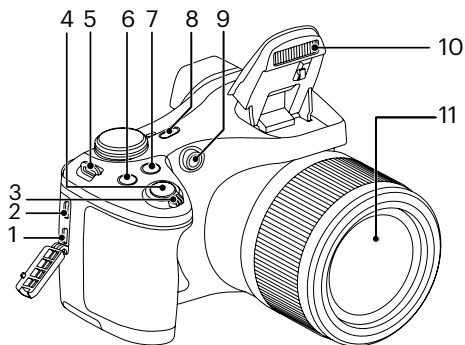

## Part Names



1. Micro HDMI Port
2. Micro USB/AV Port
3. Zoom Lever
4. Shutter Button
5. Strap Eyelet
6.  Exposure Compensation Button
7.  Continuous Shot Button
8. Power Button
9. AF Assist Beam/Self-Timer Lamp
10. Flash Lamp
11. Lens

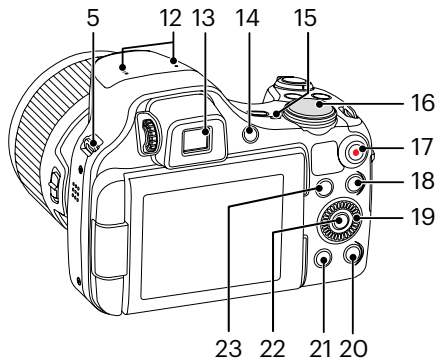

- 12. Microphone
- 13. Electronic View Finder (EVF)
- 14. EVF / LCD Switch Button
- 15. Indicator Lamp
- 16. Mode Dial
- 17. Fast Video Recording Button
- 18. Menu Button
- 19. Jog Dial
  - [ **AF** ] AF Button/Up Button
  - [ ] Delete Button/Self-Timer Button/Down Button
  - [ ] Macro Button/Left Button
  - [ ] Flash Button/Right Button
- 20. Display Button
- 21. Playback Button
- 22. SET Button
- 23. "i" Button



Rolling the jog dial can be for fast selection instead of pressing the up/down/left/right button.



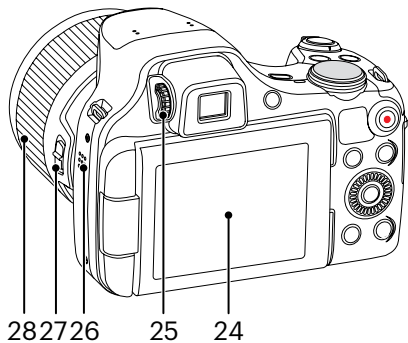

- 24. Vari-angle LCD
- 25. Diopter Adjustment Knob
- 26. Speaker
- 27. Lens Function Ring Lever
- 28. Lens Function Ring

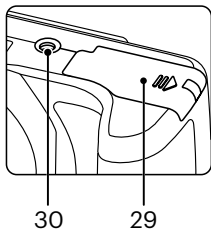

- 29. Battery Cover
- 30. Tripod Socket

## Installing Battery and Memory Card

1. Open the battery cover door.

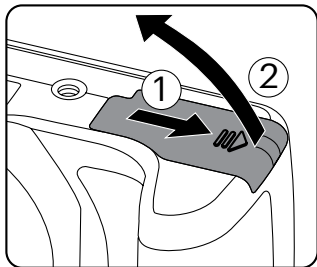

2. Insert the battery into the battery compartment according to the negative and positive directions as illustrated in the picture. Push the battery down until it locks in place.

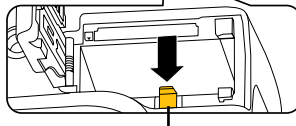
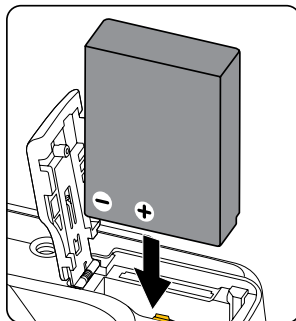

Battery Lock Knob

3. Insert the memory card into the memory card slot as shown in the diagram:

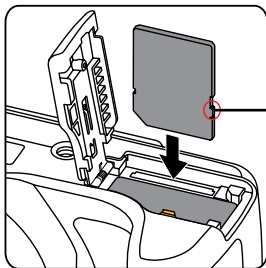

Write Protection  
Toggle Switch

4. Close the battery cover door.

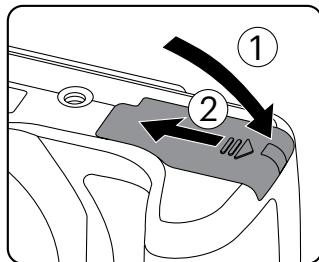

A standard SD memory card is not included in the camera packaging and needs to be purchased separately. This camera takes a standard (SD/SDHC) memory card. We recommend using a name brand memory card that is Class 4 or higher and has a capacity of 4GB to 32GB. The camera is not compatible with Micro SD, Ultra, Ultra Plus, Extreme, XC, or adapters for any of these other memory cards.





To remove your memory card, open the battery cover door, gently press the memory card to eject it and remove it carefully.

## Charging the Battery

Before you charge the battery, you should turn the camera off and insert the battery.

1. Connect the camera to the power charger using the supplied Micro USB cable.
2. Insert the plug of the power charger into the power outlet to charge the battery.

 After the battery is stored for long periods of time, use the supplied power charger to charge the battery prior to use.

 **Charging indicator:**  
Steady orange: Charging  
Steady green: Charging complete  
To maximize battery life, charge the battery for at least 4 hours the first time.

 Please charge the battery indoors between 0°C and 40°C (32°F and 104°F).

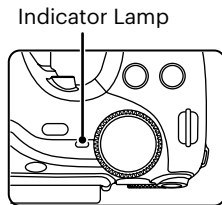
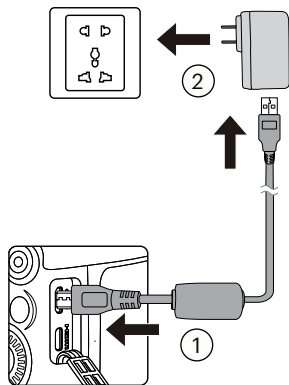

## Vari-Angle LCD

The LCD is housed in the camera's body. You may follow the directions shown below to move it as needed:

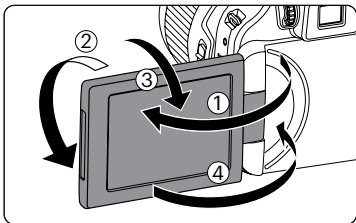

1. Open the LCD panel along the direction shown by arrow ①.
2. Rotate up to 180° along the direction shown by arrow ②.
3. Rotate up to 90° along the direction shown by arrow ③.
4. Close the LCD along the direction shown by arrow ④.



Please don't rotate the LCD with excessive force to prevent damages.



Please close the LCD along the direction shown by arrow ④ after use to protect it from scratches.

## Turning Camera On and Off

Press the Power button to turn the camera on. To turn the camera off, press the Power button again.

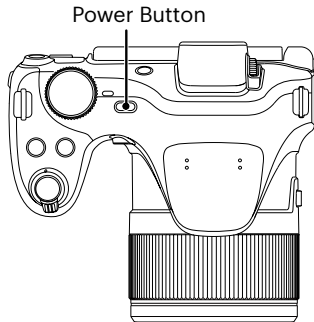

When the power is off, press and hold the playback  button to power on and enter Playback mode.

## Set your Language, Date/Time





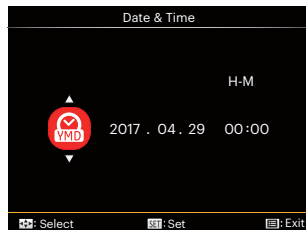

### Set your Language, Date/Time after the First Power-On

1. When you turn the camera on for the first time, the language selection screen appears.
2. Press the [ ▲ AF ]/[ ▼ ❸ ] button to select your desired language.
3. After you press the (SET) button to confirm your language selection, the Date/Time settings screen will appear.
4. Press the [ ◀ ❶ ]/[ ▶ ❷ ] button to select the Date/Time to be adjusted: Time is displayed in YYYY.MM.DD/HH:MM.
5. Press the [ ▲ AF ]/[ ▼ ❸ ] button to adjust the value for the desired Date/Time.
6. Press the (SET) button to confirm the time settings and the shooting screen will appear.



## Resetting your Language

After you set your language for the first time, follow the instructions below to reset your language.



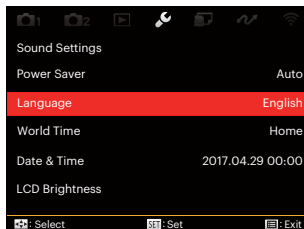























1. Press the  button, press the [ ▲ AF ]/[ ▼ 𐄂 𐄃 𐄄 ] button to select  and press the  button to enter the menu.
2. Press the [ ◀ 𐄂 𐄃 𐄄 ]/[ ▶ 𐄂 𐄃 𐄄 ] button to select .
3. Press the [ ▲ AF ]/[ ▼ 𐄂 𐄃 𐄄 ] button to select [Language] and press the  button to enter the menu.
4. Press the [ ▲ AF ]/[ ▼ 𐄂 𐄃 𐄄 ] button to select your desired language and press the  button to confirm.
5. Press the  button and the shooting screen will appear.





## Resetting Date/Time

After you set your Date/Time for the first time, follow the instructions below to reset date and time.

1. Press the  button, press the [  AF ] / [    ] button to select , and press the  button to enter the menu.
2. Press the [   ] / [   ] button to select .
3. Press the [  AF ] / [    ] button to select [Date & Time] and press the  button to enter the menu.
4. Press the [   ] / [   ] button to select the Date/Time to be adjusted: Time is displayed in YYYY.MM.DD/HH:MM.
5. Press the [  AF ] / [    ] button to press the value for your selected entry. After you finish your settings, press the  button to confirm.
6. Press the  button and the shooting screen will appear.

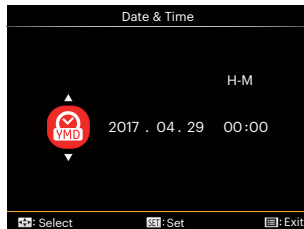
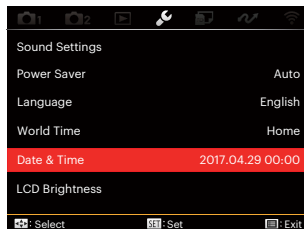

# MODE OVERVIEW

## LCD Display

### Overview of the Screen Icons in Shooting Mode

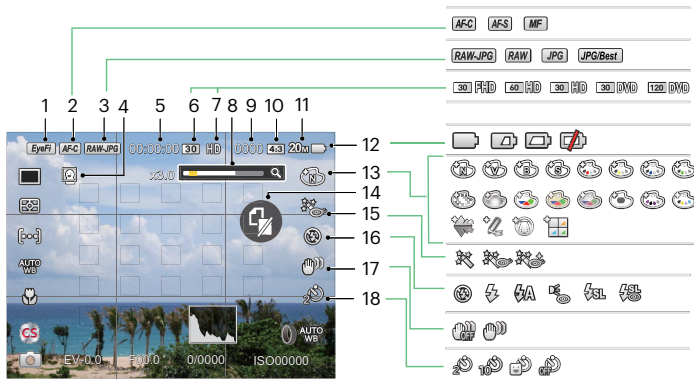

1	Eye-Fi ON (with signal)	7	Video Pixels	13	Color Effect
2	Focus Mode	8	Zoom Display (By turning the Zoom Lever)	14	No Memory Card
3	Quality	9	Number of Pictures in Static Mode	15	Beautifier
4	Face Detection	10	Ratio of Shooting Pixels	16	Flash Mode
5	Maximum Record Time	11	Image Size	17	OIS
6	Recording Speed (fps)	12	Battery Status	18	Self-Timer

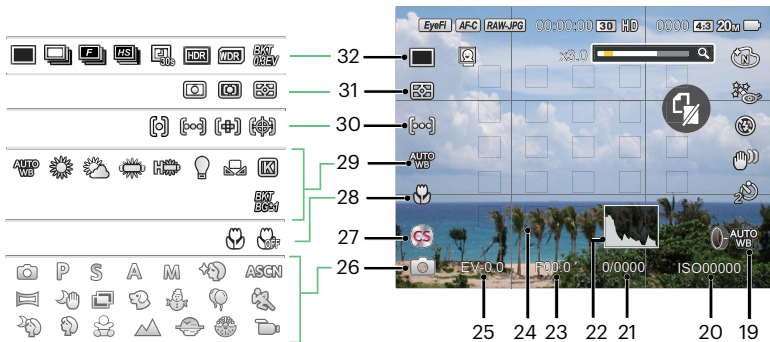

19	Lens Function Ring Custom Settings	24	Focus Frame	29	White Balance
		25	Exposure Compensation Value	30	AF Area
20	ISO Value	26	Shooting Mode	31	Expo Metering
21	Shutter Speed			32	Single / Continuous Shot / HDR / WDR / AE Bracketing
22	Histogram	27	Custom Settings		
23	Aperture Value	28	Macro Mode		

## Overview of the Screen Icons in Movie Mode

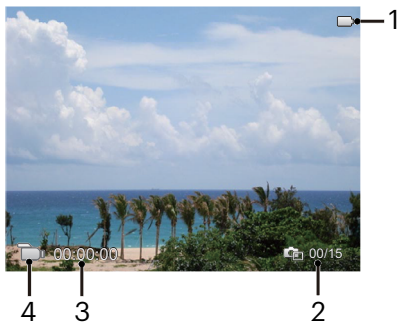

1	Battery Status
2	Number of Videos Captured
3	Continuous Recording Time
4	Movie Mode

## Overview of the Screen Icons in Playback Mode

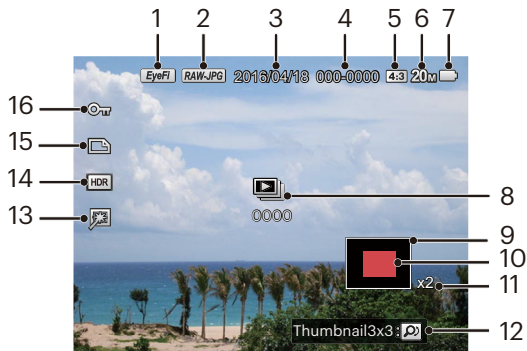

1	Eye-Fi ON (with signal)	9	Image Area
2	Quality	10	Zoom Magnification Area
3	Capture Date	11	Image Zoom Ratio
4	File Name	12	Index Prompt
5	Shooting Pixel Ratio	13	Touch-Up
6	Image Size	14	HDR
7	Battery Status	15	DPOF File Icon
8	Continuous Shot Group Playback	16	File Protection Icon

## How to Take Pictures

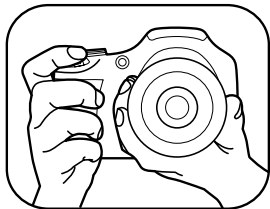



1. Hold the camera with both hands, being careful to not block the flash and lens with fingers.
2. Point the lens toward the object you want to take a picture of, and then frame it with the LCD.
3. Use the Zoom button to select Tele or Wide positions to zoom in or out on your subject.
4. Press the shutter button halfway to focus on the subject. When the focus frame turns green, press the shutter button down completely to take the picture.

## Using the Mode Dial

This camera provides a convenient Mode dial that allows you to manually switch between different modes with ease. The available modes are listed below:







Mode Name	Icon	Description
Auto Mode		In this mode, the optimal conditions for taking pictures will be set based on the subject and environment. It is the most commonly used mode for taking pictures.
Program AE	<b>P</b>	Under different scenes, the user can switch the ISO and EV value according to personal preference, the camera can automatically set the shutter speed and aperture value.
Shutter Priority	<b>S</b>	Setting allows you to adjust the shutter speed / EV value and ISO value. The camera automatically sets the aperture value based on the shutter speed and ISO value to get the most appropriate exposure value.
Aperture Priority	<b>A</b>	In this mode, you can adjust the aperture size, EV and ISO values. The large aperture is to highlight the object focused through blurring the background, while the small aperture is for clear focus on both the background and the object.

Manual Mode	<b>M</b>	This mode is for manually setting the aperture, shutter speed and ISO value.
Face Beautifier		This mode automatically enhances facial features with skin softening touches and eye brightening capabilities.
Wi-Fi® Mode		Enable image transmission and remote control by connecting smart device with Wi-Fi®.
Scene Mode	<b>SCN</b>	Choose from 14 different pre-set scene types and effects for your photos.
Movie Mode		Record videos.
Custom Settings	<b>CS</b>	The user can store frequently used shooting modes and parameters. Switching to this mode enables quick adjustment.



Please refer to the table below if any nonadjustable options in **PSAM** mode:  
(O: Available X: Not available)



Options Mode	Aperture	Shutter	EV	ISO
<b>P</b>	X	X	O	O
<b>S</b>	X	O	O	O
<b>A</b>	O	X	O	O
<b>M</b>	O	O	X	O

1. Turn the mode dial to select the **PSAM** mode you want.
2. Press the  button to configure settings.
3. Press the [  ]/[  ] button to select an adjustment setting.
4. Press the [  **AF** ]/[  ] button to adjust the parameters.
5. Press the  button to confirm the settings and enter the shooting screen.





Please note that even if an option is not able to be adjusted in a particular mode, its value will still be displayed on the shooting screen.

## Face Beautifier +

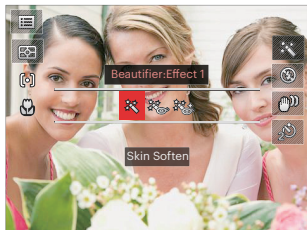
1. Turn the Mode dial to select Face Beautifier Mode (  ).
2. Press the  button and press the [  AF ]/[   ] button to select .
3. Press the [  ]/[  ] button or turn the  jog dial to select an option and press the  button to confirm and enter the shooting screen.



-  Effect 1: Skin Soften
-  Effect 2: Skin Soften + Eye Brightening
-  Effect 3: Skin Soften + Eye Brightening + Eye Enlargement

## Wi-Fi® Mode



Enable image transmission and remote control by connecting smart device with Wi-Fi®.

Before utilizing Wi-Fi® Mode, please review the following:

- Your smart device operating system version needs to be iOS 14 or higher, or ANDROID 8.0 or higher. If not, please upgrade your smart device before using the APP.
- Please do not use in places that have a high intensity magnetic field, electrostatic and electric wave interference (for example near a microwave oven), which may cause failure in receiving signals.
- To maintain a connection, please keep the camera within 10 meters (32.8 feet) without signal shielding interference.
- Please do not use Wi-Fi® connection functionality on a plane.
- The camera and the smart device can only be connected one to one.

### Downloading the APP package:

Download a dedicated installation package from the application store (APP name: PIXPRO Remote Viewer  ) and then install it.

- ANDROID™ devices : Search and download the APP “PIXPRO Remote Viewer”  in Google play, and install it following the instructions on the interface.
- iOS™ devices : Search and download the APP “PIXPRO Remote Viewer”  in APP store, and install it following the instructions on the interface.

Rotate the mode dial to  and then enter the Wi-Fi® selection interface.

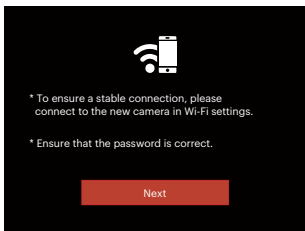





- Next: Enter the SSID interface.



Rotate the mode dial to disconnect.

Settings of Camera:

Press the [  **AF** ]/[    ] button to select options to be adjusted, and press the  button to enter the option setting interface.

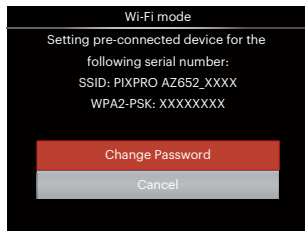

- Change Password: Enter the WPA2 PSK password refresh interface.  
Yes: Create a new WPA2 PSK password.  
No: Back to previous page.
- Cancel: Back to previous page.

### Settings of Smart Device:

1. Enable the Wi-Fi® of smart device and then search surrounding wireless devices.
2. Select the name of camera SSID to be connected and then input the eight-digit number password after WPA2-PSK on the camera.
3. Click the icon of the PIXPRO Remote Viewer APP  to enable the APP.

### Set up completion:

Once the APP is connected to the camera, functional operation can be enabled on the connected smart device.



Every AZ652 camera is shipped with a default factory Wi-Fi® password that is randomized and unique to that camera and will not change unless you wish to reset the password with a new randomly generated password. If you wish to change the Wi-Fi® password in your AZ652 from the assigned, unique factory password, you can do so by selecting and using the Change Password setting. If “Yes” is selected, a new random password will be generated and saved in the camera until changed or if you use the “Reset” function. If you reset your AZ652 to the factory settings, then the initial, randomly factory assigned and unique Wi-Fi® password will be restored to your camera. (Please refer to Reset instructions on page 107).

### Display of Wi-Fi® Connection Status:

The Wi-Fi® has successfully connected but APP is not enabled.

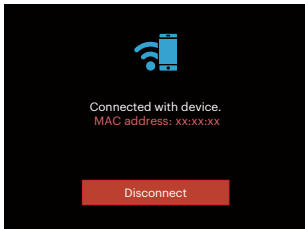

The Wi-Fi® has successfully connected and APP is enabled.

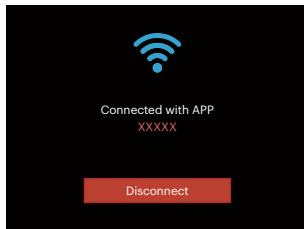

To disconnect from Wi-Fi®:



- No: Keep Wi-Fi® connected and back to previous page.
- Yes: Disconnect and back to Wi-Fi® connection screen.



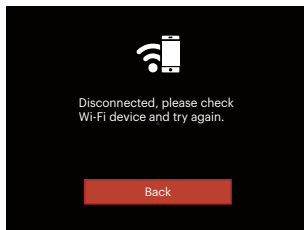



Disconnected from smart device Wi-Fi®:



- Back: Back to the SSID interface.

## Setting

The name of this camera can be changed under Wi-Fi® settings.

1. In other modes, press the  button, press the [ ▲ AF ]/[ ▼ 🗑️ 🔄 ] button to select .
2. Press the  button to enter the menu.
3. Press the [ ◀ 🌸 ]/[ ▶ ⚡ ] button to select .
4. Press the [ ▲ AF ]/[ ▼ 🗑️ 🔄 ] button to select the item to be set and press the  button to enter the menu.
5. Press the  button to confirm settings and then skip the menu.

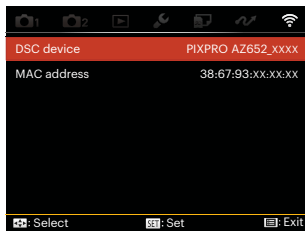







## DSC Device

The default name of DSC device is [PIXPRO AZ652\_XXXX]. Change the name of DSC device through typing.



Meanings of Interface Icons:

Icon	Description
	Delete the last letter
	Switch the display of letters in capital and lowercase
	Move the Cursor
	Switch the symbol input
	Input Space

## MAC address

Check the wireless MAC address of this camera.

## App Operating Instructions

Refer to the "PIXPRO Remote Viewer User Manual" located on the web:

Americas/Europe



<http://kodakpixpro.com/Americas/support/downloads.php>







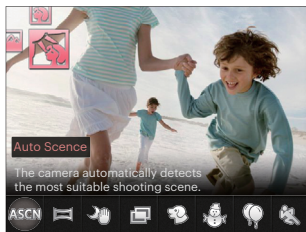







## Scene Mode SCN

You can select an appropriate mode from the 14 scene modes according to the type of environment you are shooting in. The camera then automatically configures the most appropriate settings for the best possible photos.

1. Rotate the Mode dial to **SCN**, then the LCD will display as below:









2. Press the [◀🌸]/[▶⚡] button to select a scene, and press the (SET) button to confirm.
3. If any need of changing the scene, please press the (MENU) button and then the (SET) button and finally the [◀🌸]/[▶⚡] button to reselect the scene.

Scene		Description
 ASCN	Auto Scene	The camera automatically detects the type of scene.
	Panorama Mode	For shooting up to 360-degrees of landscape.
	Handheld Night	Reduce blur when shooting low light/ illuminated scenes.
	Multi Exposure	Take several shots and overlap as a single image.
	Cat/Dog	The camera automatically takes a picture when a dog or cat face is detected.
	Snow	For subjects in the snow. Reduce underexposure.
	Party	For subjects at night without using a tripod. Capture sharp shots without blur.
	Sport	For fast-moving subjects. Capture sharp action shots without blur.
	Night Portrait	For portraits against night time scenery.
	Portrait	Most suitable for capturing people, focusing on their face.
	Children	For kids and pets. Flash is disabled for eye protection.
	Landscape	Speed adjusted for brilliant images.
	Sunset	For sunsets. Capture subjects in strong sunlight.
	Fireworks	For fireworks at night. Slow shutter speed adjusted for brilliant images. The use of a tripod is recommended with this setting.

## Auto Scene (ASCN)

In “ASCN” scene mode, the camera can intelligently detect different environments and automatically select the best scene and photo settings for you.







“ASCN” can intelligently detect the following scenes:

Mode Name	Description
 Auto	The camera automatically adjusts the exposure and focus to ensure the best possible pictures.
 Landscape	For landscapes, automatically adjusts the exposure to match the background.
 Backlit Portrait	When the sun or any other light source is behind you, automatically adjusts the foreground exposure to produce the best pictures possible.
 Macro	The Macro setting is ideal for shooting small objects or close-up photos.
 Night Landscape	For night scenes, automatically increases the ISO value to compensate for low light.
 Portrait	Most suitable for capturing people with focus on their faces.
 Night Portrait	When you take portraits at night or in low light conditions, automatically adjusts the exposure for people and night scenes.



## Panorama Mode

This feature allows you to capture a panoramic view that will have significantly more content than a single photograph. Follow the arrow while keeping the camera steady to seamlessly shoot an ultra-wide scene of up to 360 degrees.

Follow the steps below:

1. Select the Panorama Mode () and then press the  button to confirm.
2. Press the [ **AF**]/[]/[]/[] button to select a shooting direction. (Should you not select a direction, the default shooting direction is “right”.) 2 seconds later, the camera will be ready to take pictures. You can also press the  button or press the shutter button halfway down to be ready to take pictures.
3. Compose your shot on the LCD and half press the shutter button to focus on the subject. After focusing, fully press the shutter button down to take the first picture. At this time, the process dialog of panorama mode stitching appears on the screen.



4. Pan the camera according to the set direction. When the range of motion does not exceed the range that the camera can detect, the progress bar behind the arrow partially turns red. When it completely turns red, panorama mode shooting is finished.
-  Panoramic image can be played back by the method of flash playing. Please see the animation panoramic playback on page 75.
  -  In Panorama Mode, the Flash, Self-Timer, Macro Modes and Exposure Compensation are not available. Focus adjustment is also not available at this time.

 During panorama mode shooting, press the **(SET)** button to interrupt shooting and save the current pictures taken. Press the [ ▼ 🗑️ ⏸ ] button to cancel shooting and not to save the previously taken pictures.

 During panorama mode shooting, when the moving direction of the camera is wrong or the angle deviates from the internal settings, the LCD shows a warning message [Improper alignment. Please try again.] and the current pictures taken are saved.

### Multi Exposure

Suitable for shooting moving objects (as many as 6) in the same background.

 Keep camera steady before shooting. Press and hold the shutter button to take 6 photos continuously when it will stop automatically. To stop shooting, release the shutter button in the midway.

 Objects shall be moved only from left to the right in order to be recorded. Objects moving from other directions would not be recorded.

 Shooting effect will be influenced if object is moving too fast or too close.

### Cat/Dog

1. It defaults to enabling the auto shoot after entering the Cat/Dog mode. When a face of cat or dog is detected, the camera will take photos automatically. Meanwhile, you also may press down the shutter button to shoot.
  2. Press the [ ▼ 🗑️ ⏸ ] button to enter Auto Shoot menu. If this function is disabled, you may only take photos manually.
-  At most, 10 cat /dog faces can be detected at one time.

Functions that can be adjusted in each scene are as below:

Scene	Adjustable Functions
Auto Scene	Flash* <sup>1</sup> /Self-Timer
Panorama Mode	None
Handheld Night	Expo Metering/Self-Timer* <sup>2</sup>
Multi Exposure	Expo Metering
Cat/Dog	Auto Shooting/Continuous Shot/Expo Metering/Macro
Snow	Continuous Shot/Expo Metering/Flash/Self-Timer
Party	Continuous Shot/HDR/Expo Metering/Flash/Self-Timer/Macro
Sport	Continuous Shot/Expo Metering
Night Portrait	HDR/Expo Metering/Self-Timer
Portrait	Continuous Shot/HDR/Expo Metering/Flash/Self-Timer/Macro
Children	Continuous Shot/Expo Metering
Landscape	Expo Metering/Self-Timer* <sup>2</sup>
Sunset	HDR/WDR/Expo Metering/Flash/Self-Timer* <sup>2</sup>
Fireworks	Continuous Shot/Expo Metering/Self-Timer* <sup>2</sup>

\*<sup>1</sup> Means the flash as an option of Night Landscape mode in Auto Scene is non-adjustable.

\*<sup>2</sup> Means Self-Timer smile is not included in the Self-Timer.

For continuous shot, there are only [Continuous Shot] and [Time-Lapse] for selection.

## Custom Settings (CS)

The user can store frequently used shooting modes; and parameters and switch to this mode for a quick adjustment. Settings under **CS** mode (unset state or state after reset):

1. Turn the Mode dial to select the **CS** mode, and enter the setup screen, as shown in the figure below:

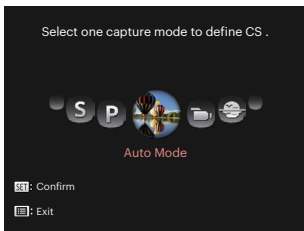

2. As shown in the figure above, press the [ ]/[ ] button to select a capture mode that you want to define as **CS**, and press the (SET) button to enter the shooting screen.
3. As shown in the figure, press the (MENU) button, and choose whether to continue the **CS** mode setting or rotate the Mode dial to skip.

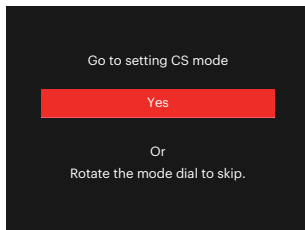

For setting under other modes (use this method to select a different custom setting):

1. Select any mode to be stored.
2. Set your desired parameters in the current mode.
3. Press the (MENU) button, press the [ AF ]/[ ] button to select (MENU), and press the (SET) button to enter the menu.
4. Press the [ ]/[ ] button to select 2.



5. Press the [ ▼🗑️🔄 ] button select [Custom Settings] and press the (SET) button to enter the menu.

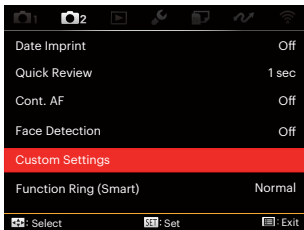

6. Select [Yes] to save or [No] to cancel.

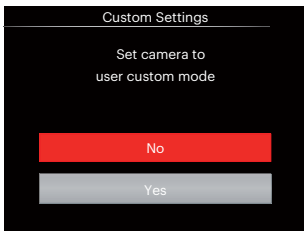

7. Turn the mode dial to switch to the custom settings ( **CS** ).
8. The photo settings you stored the last time are used.



When the **CS** mode is used for the first time, there is no preset parameter stored in the **CS** mode.



If you want to remove the parameter setting of [Custom Settings], please see the reset function on page 107 to operate.

# BASIC OPERATION

## Using EVF (Electronic View Finder)



EVF functions as the LCD, which can be used to observe the scene and objects and for playback, preview and menu operations.

EVF has the following advantages:

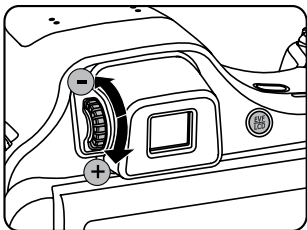
It will not be affected by ambient light and may avoid poor composition due to light reflection on the LCD.



Follow the steps below:

1. Turn the camera on and press the  button to switch to the EVF display. At this time, the LCD will become black.
2. View the scenes and objects through the EVF.
3. When the screen display is not clear, rotate the diopter adjustment knob to adjust the screen sharpness.
4. Press the  button again or restart the camera to switch back to the LCD display.

 The bending of light that takes place in a lens is referred to as refraction. The strength of refraction is measured in diopters.

 Diopter adjustment is aimed to help nearsighted (-300 or less) or farsighted (+100) individuals see clearly through the viewfinder (EVF).

## Using the Zoom Function

Your camera is equipped with two types of zoom functions: Optical Zoom and Digital Zoom. Toggle the Zoom Lever of the camera to zoom in or out on the subject while taking pictures.

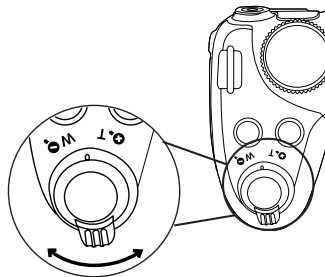

Zoom Lever

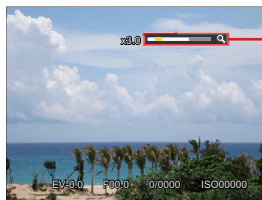

Zoom Indicator

When the Optical Zoom reaches the threshold as Digital Zoom, release and turn the Zoom lever to T to switch between the Optical Zoom and Digital Zoom.

## Display Setting

Mode: **PSAM** **SCN** **CS**

Press the **DISP** button to switch among 4 screens.

Function Message Display

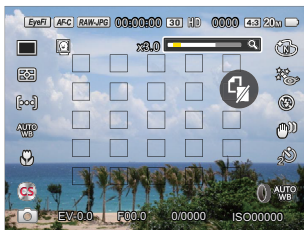

No Message Display

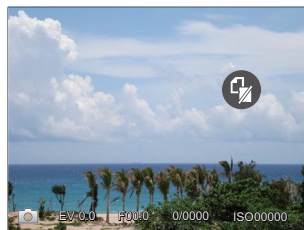



Display with Grid and Histogram



Message Display



Mode: 

Press the  button to display the playback screen, press the  button to switch among 3 screens.

Function Message Display



No Message Display



Detailed Message Display



## AF Area

In different photo shooting modes, you can select different focus methods. (Adjustable in **PSAM** mode)

1. Press the [ **▲ AF** ] button to display the settings screen.



2. Press the [ **◀** ]/[ **▶** ] button to select the following 4 modes:



Center-AF

The focus frame appears on the center of the LCD to focus on the subject.



Multi-AF

The camera automatically focuses the subject in a wide area to find the focus point.



Spot Focus

Choose the single-point focus position within the scope of focus.



Object Tracking:

Smart tracking of the object in motion under the focusing shooting.

3. Press the **(SET)** button to confirm the settings and enter the shooting screen.



After enabling spot focus, turn the jog dial to adjust the position of focus point in the screen.







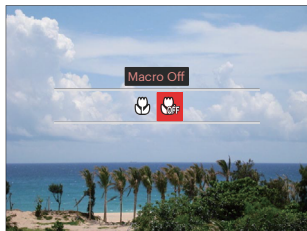

Object Tracking cannot be enabled until the camera is focused. For tracking the focus, you need to keep the shutter semi-pressed.

## Macro Mode

The Macro Setting is ideal for shooting small objects or close-up photos. This mode allows you to focus on subjects very close to the camera.

1. Press the [  ] button to enter the Macro Menu.



2. Press the [  ]/[  ] button to select the following 2 modes:
  -  Macro On  
Select this option to focus on the object closer to the lens (At the W side, the shooting distance should be more than 1 cm).
  -  Macro Off  
Select this option to disable Macro.
3. Press the  button to confirm the settings and enter the shooting screen.



## Self-Timer Mode

Using this function to take pictures at pre-set intervals. The camera can be set to shoot after 2 seconds, 10 seconds after pressing the shutter or when a smile is detected.

1. Press the [ ▼🗑️🕒 ] button to enter the Self-Timer menu.



2. Press the [ ◀️🌺 ]/[ ▶️⚡ ] button to select the following 4 modes:
  -  Self-Timer 2 sec  
A single picture is shot 2 seconds after the Shutter button is pressed.

-  Self-Timer 10 sec  
A single picture is shot 10 seconds after the shutter button is pressed.
-  Self-Timer Smile  
Press the shutter button and a picture will be taken immediately after a smile is detected.
-  Self-Timer Off  
Disables the Self-Timer.

3. Press the (SET) button to confirm the settings and enter the shooting screen.
  -  When enabling the Self-Timer, pressing the shutter or the [ ▼🗑️🕒 ] button can disable the Self-Timer and return to the shooting screen while keeping the Self-Timer setting.



When enabling the Smile Detection, pressing the shutter or the **(SET)** button can disable the Self-Timer and return to the shooting screen while keeping the Self-Timer smile setting.

Self-Timer settings will remain after completion of shooting with the Self-Timer. They can be canceled by switching modes or by turning the camera off and then on again.





## Flash Mode

The flash provides supplemental light for the scene. The flash is usually used when shooting against the light to highlight the object; it is also suitable for metering and shooting in darker scenes to improve the exposure.

1. Press the [▶⚡] button to enter the flash settings menu.



2. Press the [◀🌸]/[▶⚡] button to select the following 6 modes:
  -  Force Off  
Flash is turned off.

-  **Fill Flash**  
The flash goes off when a picture is taken, supplementing the existing light in a scene and helping to eliminate shadows.
-  **Flash Auto**  
Camera flash goes off automatically based on existing light conditions.
-  **Red-Eye Reduction**  
The camera emits a brief pre-flash before the picture is taken to reduce red-eye effects.
-  **Slow Sync.**  
This allows you to take pictures of people at night that clearly show both your subjects and the night time backdrop. The use of a tripod is recommended when shooting with this setting.
-  **Slow Sync.+Red-Eye Reduction**  
Use this mode for slow synchrony shots with red-eye reduction.

3. Press the  button to confirm the settings and enter the shooting screen.

 After pressing the shutter button half way to achieve focus lock, the flash will automatically pop up if needed.

## WB (White Balance) Mode





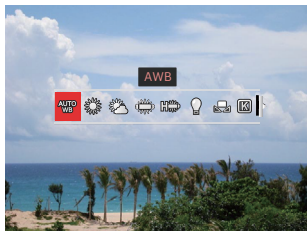

The white balance function allows adjustment of the color temperature for different light sources. (Adjustable in **PS AM** Mode)

Follow the steps below to set white balance of the camera:

1. Press the **SET** button to enter white balance menu.



2. Press the [ **◀**  ]/[ **▶**  ] button to select the following 9 modes:

- **AUTO WB** AWB
  -  Daylight
  -  Cloudy
  -  Fluorescent
  -  Fluorescent H
  -  Incandescent
  -  Manual WB  
Set WB according to the current light source, press the **SET** button to set.
  -  Color Temp. (1900K-10000K)  
Press the **SET** button to enter and turn the **◉** jog dial to adjust the color temperature value.
  - **BKT WB** WB Bracketing  
Press the shutter button once to take three photos with different WB settings.
3. Press the **SET** button to confirm the settings and enter the shooting screen.

## WB Bracketing:

Press the **SET** button to enter options and then press the [ **▲ AF** ]/[ **▼** **☒** **☺** ]/[ **◀** **☚** ]/[ **▶** **☛** ] button to adjust the shift and turn the **⦿** jog dial to adjust the BKT value (0, 1 and 2).

Rotate clockwise to adjust X axis (B-A). BKT value

Rotate counterclockwise to adjust Y axis (G-M). BKT value

Press the **SET** button to confirm your settings.

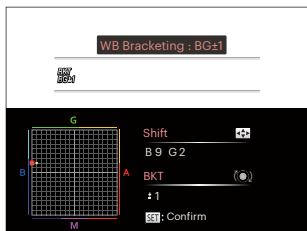

WB bracketing is for setting the bracketing range. Shift to both sides for 3 spaces at most. If at the page border, shift only to the other side and 2 photos can be taken. If no shift, only one photo can be taken.

## Continuous Shot Mode

Functions that can be enabled under each mode may be different.





Mode:  **PSAM** +  **SCNCS**



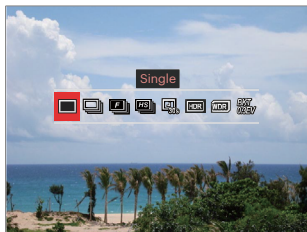



For setting the single, continuous shot, Time-Lapse, HDR, WDR or AE bracketing functions.

Please follow the following steps to set:

1. Press the  button to enter the continuous shot menu.



2. Press the [   ] / [   ] button to select the following 8 modes:
  -  **Single**  
Capture a single shot only.

-  **Continuous Shot**  
For taking more than one picture continuously.
-  **Cont. Shot-Fast (2M)**  
For continuous shot with 2M pixels.
-  **Cont. Shot-High Speed (VGA)**  
For continuous shot with VGA pixel.
-  **Time-Lapse**  
Take pictures based on the preset interval (30sec/ 1min/ 5min/ 10min). Press the  button to select the interval time.
-  **HDR (-1EV, 0EV, +1EV)**  
This setting is to control the high dynamic image range in taking still pictures, with vivid effect in highlight and that the effect in dark parts can identify the outline and depth of the object. (Use of tripod is recommended)



- HDR effect may be affected by handshaking, light, subject movement or shooting environment.
- The flash is not available in HDR mode.
- It may take longer to save a photo in HDR.



**WDR** (Wide Dynamic Range)  
When the camera detects that there is a big contrast in brightness between scenes and such scenes are against the light, it will automatically adjust the brightness and saturation to capture an image that better represents the scene.



- WDR is not available in mode.
- For WDR in the **SCN** mode:  
 : adjustable;  
 / : unadjustable and on by default;  
Other modes: not available.



Please refer to page 136~137 for a detailed explanation of HDR and WDR effects.



**AE Bracketing** (0.3EV, 0.7EV, 1.0EV, 1.3EV, 1.7EV, 2.0EV)  
The camera will automatically and continuously take three pictures separately with a brightness of original, darker and brighter as long as you press the shutter once. Press the button to select the range of exposure.

3. Press the button to confirm the settings and then enter shooting screen.

Mode:



Single













WDR



## Exposure Compensation Functions Setting

The EV Function Menu of the camera includes functions, such as EV (Exposure Value) Adjustment, ISO, Shutter Adjustment, Aperture Adjustment, etc. Using the appropriate Function Settings can improve your pictures.

Please follow the steps below to set:

1. Press the  button to display the Settings screen.  
4 options in [ Exposure Compensation Functions Setting ]:
  - EV Adjustment
  - ISO Adjustment
  - Shutter Speed Adjustment
  - Aperture Adjustment
2. Press the [   ]/[   ] button to select the Setting options.
3. Press the [  **AF** ]/[    ] button to adjust the option values.
4. Press the  button to complete the setting and enter shooting screen.

### EV Adjustment

Set up Exposure Compensation to adjust the picture brightness. If there is very high contrast between the photographed object and the background, the brightness of the picture can be adjusted as necessary. (This can be adjusted in **PSA**   Mode)

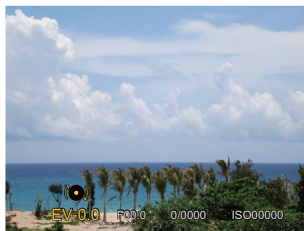

The adjustable range of exposure value is from EV -3.0 to EV +3.0.

## ISO Adjustment

ISO allows you to set the sensitivity of the camera sensor. Please use a higher ISO value in darker places and a lower value in brighter conditions.

(This can be adjusted in **PSAM** + Mode)

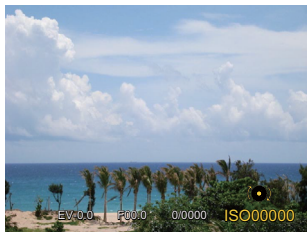

Options of ISO value: Auto, 100, 200, 400, 800, 1600 and 3200.

## Shutter Speed Adjustment

For shutter speed, the camera may automatically set the aperture value corresponding to the manually set shutter speed so as to obtain a most suitable exposure value. The movement of object may be shown by adjusting the shutter speed. High shutter value can help you more clearly capture fast moving objects, while low shutter value can better show the movement of objects. (This can be adjusted in **SM** Mode)

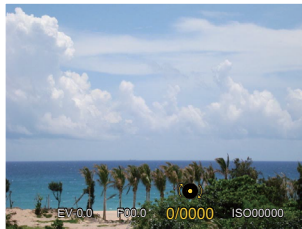



## Aperture Adjustment

You can adjust the aperture size value. Selecting a large aperture opening will emphasize the point of focus and show a blurry background and foreground. A small aperture opening will keep both the background and main object in clear focus. (This can be adjusted in **AM** Mode)

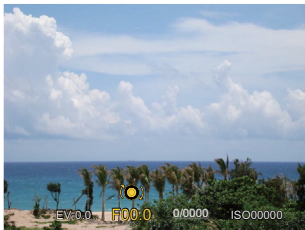

## Using Quick Recording

In Photo Shooting Mode, press the  button to begin recording video.

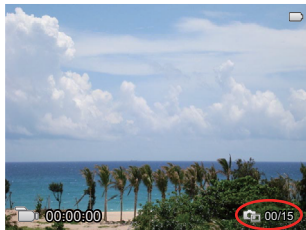

15 pictures at most can be taken by pressing the shutter when recording.

The sizes of images taken are as below when playing them back:

FHD -> 2M **2M**

HD -> 1M **1M**

DVD -> VGA **VGA**

Once you are finished, press the  button again to stop recording. The camera will save the video and return to the shooting screen.

## "i" Button Function Menu

Functions that can be enabled are different under each mode.



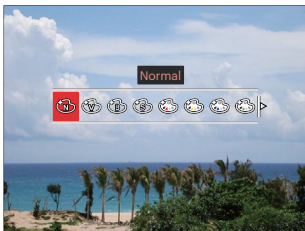

Mode: **PSAM** 

The image color setting allows you to select different effects.

1. Press the  button to select the Image color setting menu.



2. Press the [   ]/[   ] button to select the image color setting options.

-  Normal
-  Vivid
-  Black and White
-  Sepia

-  Partial Color-Red
-  Partial Color-Yellow
-  Partial Color-Blue
-  Partial Color-Green
-  Dreamy
-  Vignetting
-  EKTACHROME Film
-  KODACHROME Film
-  KODACOLOR Film
-  Salon
-  Punk
-  Negative
-  Reflection
-  Sketch
-  Fish Eye
-  4 Grids - Stylish(2M)



Fish Eye effect is not available when shot size is 20M.

## Using the Lens Function Ring

There is a lens function ring lever in one side of the lens. Moving it up and down can switch among ZOOM/AF, SMART and MF mode.

### Zoom/AF Mode

Rotate the lens function ring for optical zoom.

1. Switch the lens function ring lever to position **ZOOM /AF**.

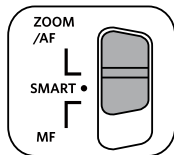

2. Rotate the lens function ring to optically zoom the object.





Rotating the lens function ring in Zoom/AF mode is only for optical zoom.

## Function Ring (Smart) Mode

Rotate the lens function ring to set parameters of aperture, shutter, ISO, EV, etc.

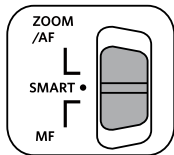
1. Switch the lens function ring lever to position **SMART**.



2. Rotate the lens function ring or turn the  jog dial to select options needed.

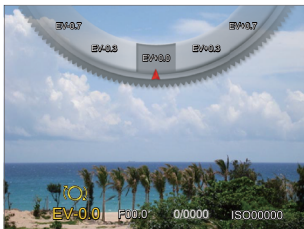

3. Press the  button to complete the setting and enter shooting screen.

 The selection of functions of Function Ring (Smart) in the menu is needed before using Function Ring (Smart) mode. The default setting is Normal. (See P91 for details)



Options	Referred Pages
Normal	P64
Aperture Priority	P66
Shutter Priority	P65
EV	P64
ISO	P65
Continuous Shot	P62
Color	P67
White Balance	P60
Image Size	P82
Expo Metering	P79
Flash	P58
AF Area	P55

## MF(Manual Focus) Mode

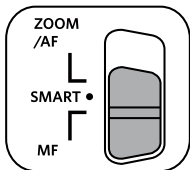

Rotate the lens function ring for manual focus.

1. Switch the lens function ring lever to position **MF**.



2. If the lens function ring is operated or the  jog dial is turned the focus enlargement frame will appear on the LCD. After clear focus is achieved through manual adjustment, press the  button to close the focus enlargement frame. The camera will return to the normal shooting screen. Semi-pressing the shutter button will have no effect; you need to fully press the shutter button to take a normal photo.







-  Manual focus works only under the **P S A M** mode.
-  The MF assist needs to be enabled in the menu before it will function. (See P85 for details)

# PLAYBACK

## Viewing Photos and Videos

For viewing taken photos and videos on the LCD:

1. After pressing the , the last photo or video clip taken will be displayed on the LCD.
2. Press the []/[] button to scroll through the photos or video clips stored in the built-in memory or on the Memory Card.
3. To play a selected video clip, press the  button to enter the movie playback mode.







An operation guide appears on the screen when playing back a video. Press the appropriate buttons to enable the corresponding functions.

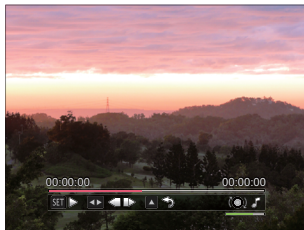



Under Playback











Paused



 	Pause
 	Rewind
 	Fast Forward

	Clockwise Volume Up
	Counterclockwise Volume Down
	Volume
	Mute

 	Play
 	Frame Backward
 	Frame Forward
 	Cancel Playback

## Thumbnail View

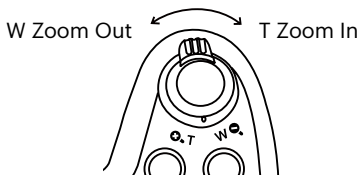

When in Playback Mode, rotate the Zoom Lever counter to the **W** position to display thumbnail images of the photos and videos on the screen.



1. Slide the Zoom lever to switch between 3 x 3 and 4 x 4 thumbnails.







2. Press the [ **▲ AF** ]/[ **▼** ]/[ **☺** ]/[ **◀** ]/[ **▶** ] button to select a picture or video clip to view and press the **SET** button to restore it to the original size.
3. As shown in the picture, press the **☰** button to select index mode.  
4 options in [ Index Mode ] :
  - Single Index
  - Date Folder
  - Cont. Group
  - Slide Show

 When the icon  appears, it means this is a video file.





 When the icon  appears, it means this is a continuous group file.

## Using Zoom Playback (for still pictures only)

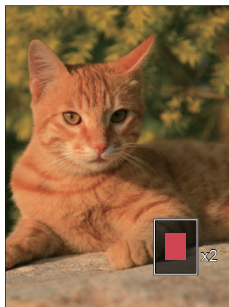
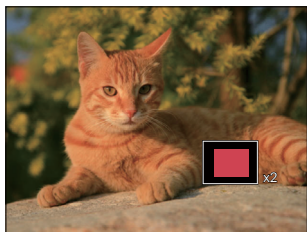
When playing back photos, you can also use the Zoom Lever to zoom in on the photos 2 to 8 times their original magnification.

1. Press the  button to switch to Playback Mode.
2. Press the []/[] button to select a picture to be zoomed in on.
3. Rotate the Zoom lever to  position to zoom in.
4. Roll the  jog dial clockwise to zoom in and counterclockwise to zoom out.
5. The bottom right corner of the LCD will display the number of times the image is magnified and area of the photo shown.



6. Press the [AF]/[]/[]/[] button to navigate and select a portion of the photo to be zoomed in on.
7. Press the  button to return the image to its original scale.







Movie images cannot be magnified.



## Continuous Shot Group Playback

High speed (VGA) and fast (2M) Continuous Shot images can be played back as a group.

1. Press the  button to enter Playback Screen.
2. Press the []/[] button to select Continuous Group.
3. Press the  button to start playback.

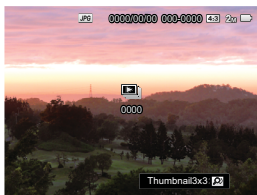



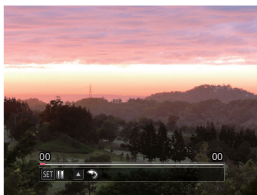

Cont. Group









Playing



Pause

 	Pause
 	Cancel Play (back to 1:1 playback for Continuous Group)





Playing

 	Play
	Previous Photo (loop available only in Continuous Group)
	Next Photo (loop available only in Continuous Group)
 	Cancel Play (back to 1:1 playback for Continuous Group)

Pause

## Animation Panorama Play

Panoramic Animation Playing is to play full size image in accordance with the shooting direction. After playing, it will automatically return to the static screen of panoramic image.

1. Press the  button to enter Playback Screen.
2. Press the [  ]/[  ] button to select animated panoramic photos.
3. Press the  button to play in selected shooting direction.







Video Panorama





Playing



Pause



 	Pause
 	Cancel Play

 In the process of panoramic animation playback, press the [  **AF** ] button to stop playing and return to the playback screen.





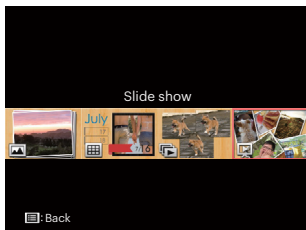

 Picture will not be rotated during panorama play or pause.

## Slideshow





This setting allows you to view all the stored images as a slideshow.

1. Press the  button to enter playback screen.
2. Rotate the Zoom lever counter to the **w**  position to display thumbnails 3 x 3 and then press the  button to select the index mode.

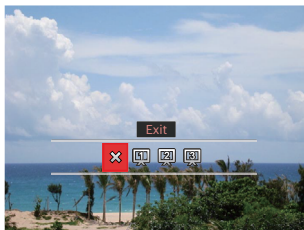

3. Press the [  ]/[  ] button to select Slideshow Playing and then press the  button to enter slide option.
4. Press the [  ]/[  ] button to select play effect and then press the  button to confirm.



-  Exit
-  Type 1: Slow-in and slow-out
-  Type 2: Separate in middle and move off to the left and right
-  Type 3: Separate into blocks and spin in

## Deleting Photos and Videos

In Playback Mode, press the [ ▼🗑️👉 ] button to delete your photos and videos.

To delete photos or videos:

1. Press the [⏮] button to switch to playback mode.
2. Press the [ ◀️🗑️ ]/[ ▶️🔌 ] button to select the photos or videos to be deleted.
3. Press the [ ▼🗑️👉 ] button and the deletion screen is displayed.

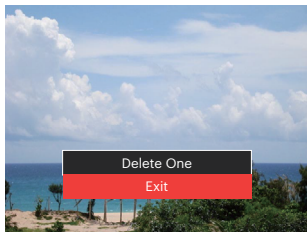

4. Press the [ ▲AF ]/[ ▼🗑️👉 ] button to select [Delete One] or [Exit] and press the [SET] button to confirm.



Erased photos/video clips cannot be recovered.



Please refer to page 98 for instructions on deleting more than one image at a time.

# USING THE MENUS

## Shooting Menu

Mode: **PSAM** **SCNCS**

1. In Shooting Mode, press the button to enter the Shooting Menu.

12 options in [ Shooting Menu ]:

- Continuous Shot Mode (refer to P62)
- Expo Metering
- AF (Auto Focus) Area (refer to P55)
- WB (White Balance) Mode (refer to P60)
- Macro Mode (refer to P56)
- Color (refer to P67)
- Flash mode (refer to P58)
- OIS (Optical Image Stabilization)
- Self-Timer Mode (refer to P57)
- Beautifier (Adjustable only in Mode)
- Select Scene (Adjustable only in **SCN** Mode)
- Menu

2. Press the [ **AF** ]/[ ] button to select the shooting menu to be set.

3. Press the [ ]/[ ] button or turn the jog dial to select options of the shooting menu to be set and then press the button to confirm.

Refer to the following pages for more details about each setting.





Functions that can be enabled are different under each mode.

## Expo Metering

Use this setting to select the “target” size of the camera’s field of view to be metered.





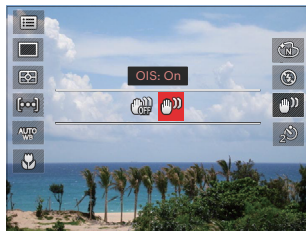

-  Spot  
For metering the block displayed in the center of the screen.
-  Center  
For metering the object in the center of the screen.
-  AiAE (Artificial Intelligence AE)  
Evaluates the light intensity at multiple points in the frame and automatically determines the best value for the light meter.

## OIS (Optical Image Stabilization)

This mode can help reduce photo blur caused by unintentional shaking, or low light.





-  OIS: Off
-  OIS: On
-  Use this image stabilization mode in dark environments.
-  Shooting in a windy or unstable environment (such as a moving vehicle) may cause blurry images.
-  You may not need OIS when using a tripod.

## Beautifier

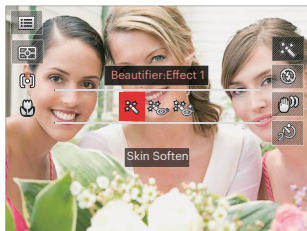
Select the effect for Face Beautifier Mode.



-  Effect 1: Skin Soften
-  Effect 2: Skin Soften  
+ Eye Brightening
-  Effect 3: Skin Soften  
+ Eye Brightening  
+ Eye Enlargement





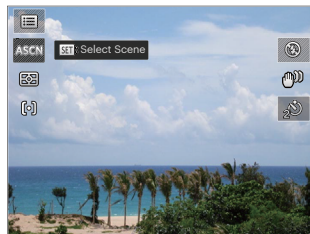

















## Select Scene

Select a scene mode under SCN Mode.



## Shoot Setting1

Mode:  **PSAM**  **SCNCS**  

1. Press the  button, press the [  **AF** ] / [    ] button to select .
2. Press the  button to enter the menu.
3. Press the [   ] / [   ] button to select .  
6 options in [Shoot Settings 1]:
  - Image Size
  - Movie Size
  - Quality
  - MF Assist
  - AF Assist Beam
  - Digital Zoom
4. Press the [  **AF** ] / [    ] button to select the item to be set and press the  button to enter the menu.
5. Press the [  **AF** ] / [    ] button to select an option and press the  button to confirm.

 Functions that can be enabled are different under each mode.



## Image Size

The Size setting refers to the image resolution in pixels. A higher image resolution allows you to print that image in larger sizes without degrading the photo image quality.

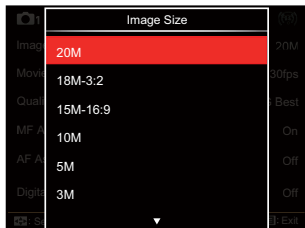

- 20M: High quality printing
- 18M-3:2: full size printing
- 15M-16:9: 16:9 display
- 10M: poster printing
- 5M: A3 printing
- 3M: A4 printing
- 2M-16:9: 4"x 6" printing
- VGA: E-Mail



The larger the number of recorded pixels, the larger the file size and the fewer files that can be saved on your memory card.

## Movie Size

Set the image resolution used during video recording.

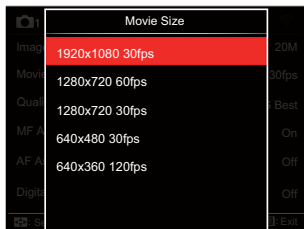



Total time of video recorded for each setting:

No.	Image Pixels	Frames (fps)	Recommendation	Recording Time (approximate) (4GB)
1	1920 x 1080 *	30	Class 6	30 Minutes
2	1280 x 720 *	60	Class 6	33 Minutes
3	1280 x 720 *	30	Class 4	59 Minutes
4	640 x 480	30	Class 4	105 Minutes
5	640 x 360	120	Class 6	54 Minutes

 \* The longest recording time is 29 minutes at one time.

 When recording in higher pixel resolutions for extended periods of time, this can cause the camera to generate heat. This is not a camera malfunction.

 When the video format is set as 640 x 360 (120fps), shooting time is 30 seconds, playback time is 2 minutes.

 Sound recording is disabled when 640 x 360 120fps is chosen.

## Quality

The Quality setting can be used to adjust the image compression ratio.

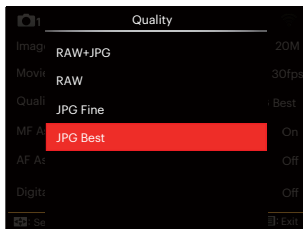

- RAW+JPG (Available in **PSAM** mode)  
Creates two images: one in RAW and the other in JPG best.
- RAW (Available in **PSAM** mode)  
The image file will contain more data that can be used for the purpose of editing on a computer.
- JPG Fine
- JPG Best

If RAW or RAW+JPG is selected, the settings of Colour Effect, Continuous Shot, Cont.Shot-Fast (2M), Cont.Shot-High Speed (VGA), HDR and AE Bracketing cannot be adjusted.

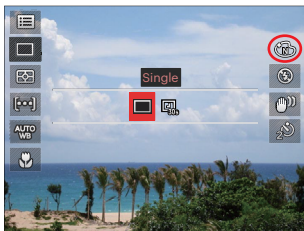

The RAW file format provides lossless compression of the image data, which is not processed by the camera. The RAW file may be opened and modified using the image processing software, PhotoStudio Darkroom, that is located on the CD-ROM included with this camera. PhotoStudio Darkroom supports Windows 7/8/10 and Mac OS X (V10.8-V10.11).

### MF (Manual Focus) Assist

Enables an enlarged focus window during the use of manual focus to provide the user better visibility for focus control. (Adjustable in **PSAM** mode)

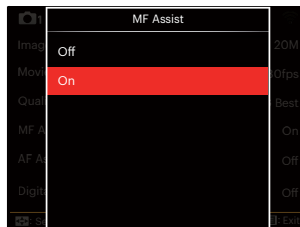

- Off
- On

## AF Assist Beam

In a darker environment, the AF assist beam setting can be turned on for better focus.

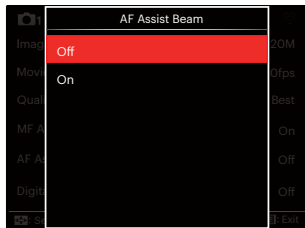

- Off
- On

## Digital Zoom

This setting is for adjusting digital zoom. If this function is disabled, only optical zoom can be used.

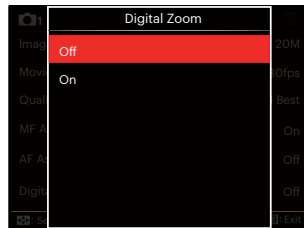

- Off
- On

## Shoot Setting 2

Mode: PSAM + SCNCS

1. Press the button, press the [ AF ] / [ ] button to select .
2. Press the button to enter the menu.
3. Press the [ ] / [ ] button to select 2.  
6 options in [Shoot Settings 2]:
  - Date Imprint
  - Quick Review
  - Continuous AF
  - Face Detection
  - Custom Settings
  - Function Ring (Smart)
4. Press the [ AF ] / [ ] button to select the item to be set and press the button to enter the menu.
5. Press the [ AF ] / [ ] button to select an option and press the button to confirm.



Functions that can be enabled are different under each mode.

## Date Imprint

Include a Date/Time stamp on the photo image.

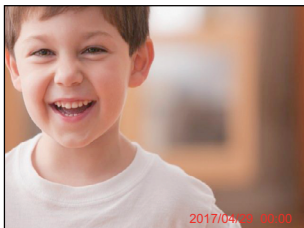
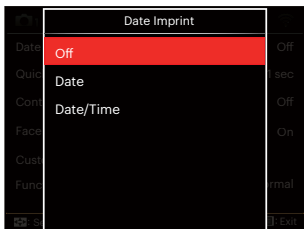

- Off
- Date
- Date / Time

## Quick Review

This option enables a quick review of images immediately after capture. Each picture will be displayed on the LCD screen per the selections below.



- Off
- 1 sec
- 2 sec
- 3 sec

## Continuous AF

Use the Continuous AF setting to be able to continuously focus automatically when taking pictures.

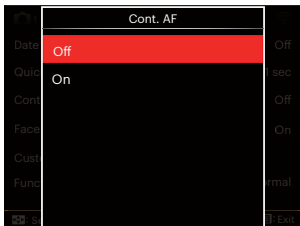

- Off
- On

## Face Detection

Detects and focuses on faces to make all faces as clear as possible in Photo Mode.



1. Hold the camera steadily and then focus on the object to detect its face. A focus frame will appear at the face on the screen when a face is detected.

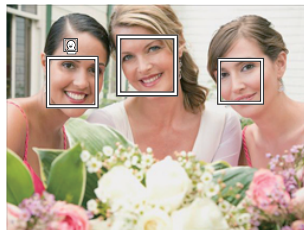



2. Press the shutter button half-way down to focus. The LCD will show a green focus frame when the subject is in focus.

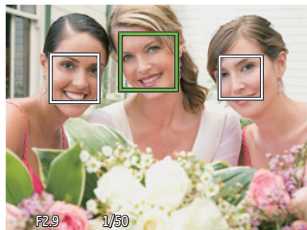

3. Press the shutter button all the way down to take pictures.



The closed eyes detection is usually on. If the camera detects in the course of quick review there is a face with eyes closed, a prompt of closed eyes will appear

## Custom Settings

Custom settings stores the current movie shooting mode and its parameters. The stored mode and parameters are automatically used in Custom Settings mode.

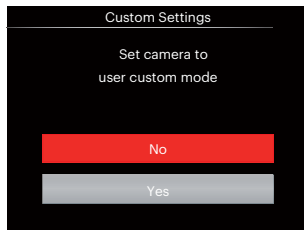

- No
- Yes

## Function Ring (Smart)

The options listed below can be set as Function Ring (Smart) Custom. Once set, the chosen function can be quickly adjusted with the lens function ring during shooting.

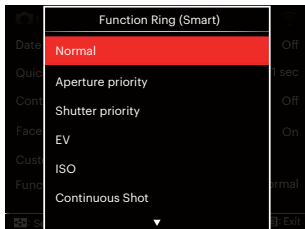



- Normal
- Aperture Priority
- Shutter Priority
- EV
- ISO

















- Continuous Shot
- Color
- White Balance
- Image Size
- Expo Metering
- Flash
- AF Area

## Playback Menu

Mode: 

1. Press the  button to display the playback screen and press the  button to enter the menu.







7 options in [Playback Menu]:

-  Menu
  -  Display Mode
  -  Rotate
  -  Color
  -  HDR
  -  Touch-Up
  -  Resize
2. Press the [  AF ]/[   ] button to select the playback desired and press the  button to enter.
  3. Press the [   ]/[   ] button to select an option and press the  button to confirm.

Refer to the following pages for more details about each setting.





## Menu

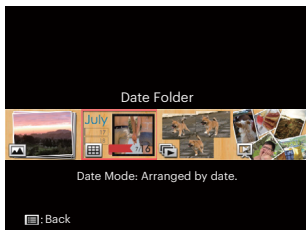

7 options in [ Menu ]

- Shoot Settings 1  (See P81 for details)
- Shoot Settings 2  (See P87 for details)
- Playback Settings  (See P97 for details)
- General Settings  (See P101 for details)
- File Settings  (See P104 for details)
- Connection Settings  (See P108 for details)
- Wi-Fi® Settings  (See P41 for details)

## Display Mode







-  Normal Mode: Display all images.
-  Date Mode: Arranged by date.
-  Cont. Photo Mode: Arranged by Cont. Photo Group.
-  Slide Show

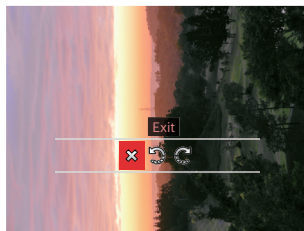

-  The Date Folder is displayed in date order based on photo shooting date/time.
-  If there is no continuous shot image file in memory, continuous photo mode cannot be enabled.

## Rotate

You can use this setting to change the orientation of the picture.



-  : Exit
-  : Turn Left
-  : Turn Right

-  Videos and panoramic pictures cannot be rotated.
-  The rotated picture file will replace the original photo.

## Color

This setting allows you to change the picture color effect. The file is saved as a new photo and stored in memory together with the original photo.

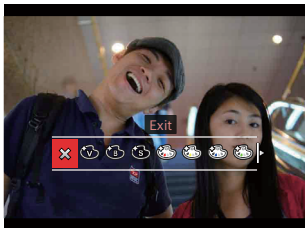

-  Exit
-  Vivid
-  Black and White
-  Sepia
-  Partial Color-Red
-  Partial Color-Yellow
-  Partial Color-Blue
-  Partial Color-Green
-  Dreamy

-  Vignetting
-  Salon
-  Punk (4M)
-  Negative (8M)
-  Reflection
-  Fish Eye
-  4 Grids - Stylish (2M)

 In playing back single photos, press the **i** button to enter the color effect setting menu.

 Fish Eye effect is not available when shot size is 20M.

## HDR HDR

With the HDR function, pictures that are overexposed may be corrected to optimize the highlights and lowlights captured to more accurately represent the actual scene.

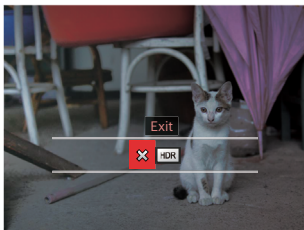

✕ : Exit

HDR : HDR

Select HDR with HDR :

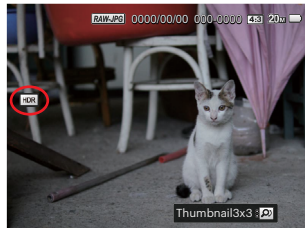

After using the HDR function, the image will be saved as a new file and the original file is still stored in the memory.

## Touch-Up

The playback beauty feature allows for beautification using three individual effects.





 : Exit

 : Red-Eye Reduction

 : Skin Soften

 : Eye Brightening

 : Eye Enlargement

 The Touch-Up referred to is the individual use of three effects. Beauty Mode allows you to select one, two, or all three of the effects combined.

Select  with touch-up:



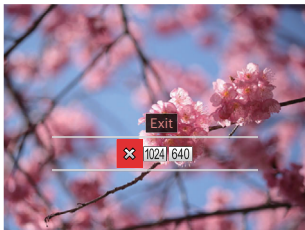

## Resize

This setting allows you to resize a picture to a particular resolution and saves it as a new picture.



 : Exit

 : Resize to 1024x768





















 : Resize to 640X480

 Only for adjusting pictures with high resolution to those with low resolution.

 Sizes of photos taken in panorama mode or rotated cannot be adjusted.

## Playback Settings

Mode:  PSAM  SCNCS  

1. Press the  button, press the [  AF ] / [    ] button to select .
2. Press the  button to enter the menu.
3. Press the [   ]/[   ] button to select .  
5 options in [ Playback Settings ]:
  - Protect
  - Delete
  - DPOF
  - Trim
  - Play Slide Show
4. Press the [  AF ]/[    ] button to select the item to be set and press the  button to enter the menu.
5. Press the [  AF ]/[    ] button to select an option and press the  button to confirm.

Refer to the following pages for more details about each setting.



## Protect

To prevent any pictures or videos from being accidentally erased, use this setting to lock one or all of the files.

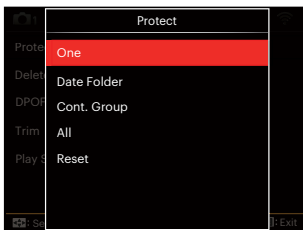



- One  
Lock the selected photo or video if they are unprotected; unlock the selected photo or video if they are protected.
- Date Folder  
Protect all photos in the Date Folder.
- Cont. Group  
Protect all photos in the Cont. Group.
- All  
Lock all photos or videos.
- Reset  
Cancel all locked photos or videos.

## Delete

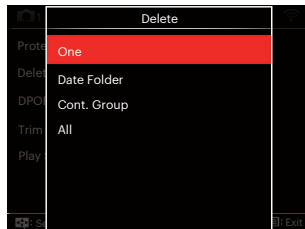
You can delete one or all photo/video files.



- One  
Delete one photo or video.
- Date Folder  
Delete all photos in the Date Folder.
- Cont. Group  
Delete all photos in the Cont. Group.
- All  
Delete all photos or videos.

 The “” indicator means a file is protected. File protection must be removed before a file can be deleted.

 Deleting files will cause DPOF settings to be reset.

 When one photo in the Cont. Group and Date Folders is protected, it will be kept but any other photos will be deleted.

 Deleted files will be permanently deleted and will not be able to be recovered or restored.

## DPOF (Digital Print Order Format)

The DPOF feature allows you to compile and select a group of pictures that you would like to print and will save your selection on the memory card so that you can use the memory card to print without having to individually specify the photos you want to print.



- One
- All
- Reset

 The printer that supports DPOF is needed for photo printing.

## Trim

The Trim setting allows you to crop photos and save them as new pictures.

1. Select [Yes] to confirm trim. Toggle the zoom lever or turn the  jog dial to select the aspect ratio and press the [▲AF]/[▼📷📷]/[◀📷]/[▶📷] buttons to adjust the part you want to trim.

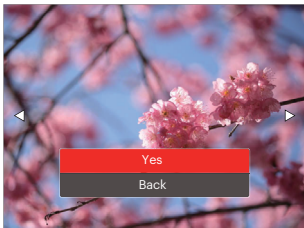

2. Press the  button and the [Save change?] prompt appears. Select [✔️] to change and save the picture. Select [❌] to cancel changes and return to the trim prompt screen.



The image cannot be clipped/trimmed again once it has been clipped to 640X480.



Videos, RAW files cannot be trimmed.



A trimmed picture cannot be trimmed again.

## Play Slide Show



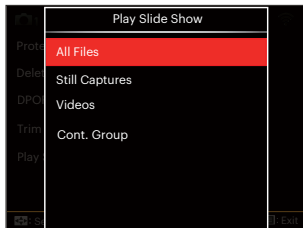



















This setting allows you to view all the stored images as a slideshow.



- All Files  
To display and play back all images in memory card.
- Still Captures  
To display and play back images of photo files in memory card.
- Videos  
To play back movies on memory card.
- Cont. Group  
To only play back images arranged by cont. group in memory card.

## General Settings

Mode :  **PS**  **AM** +  **SCN**  **CS**  

1. Press the  button, press the [  **AF** ] / [    ] button to select .
2. Press the  button to enter the menu.
3. Press the [   ] / [   ] button to select   
6 options in [General Settings] :
  - Sound Settings
  - Power Saver
  - Language
  - World Time
  - Date & Time
  - LCD Brightness
4. Press the [  **AF** ] / [    ] button to select the item to be set and press the  button to enter the menu.
5. Press the [  **AF** ] / [    ] button to select an option and press the  button to confirm.

Refer to the following pages for more details about each setting.

## Sound Settings

With this setting you may adjust the sound volume.

Press the [ ◀ ]/[ ▶ ] buttons to adjust the volume and press the (SET) button to confirm.

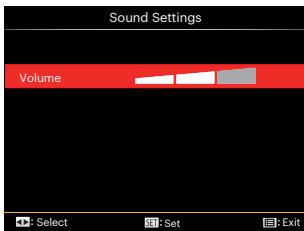

## Power Saver

This setting allows you to save power and get the maximum possible running time for your camera's batteries. Turn the LCD and camera off automatically after a consecutive period of inactivity.

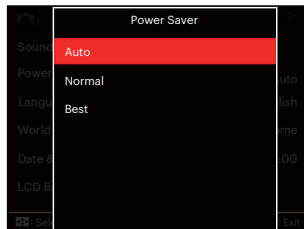

- Auto
- Normal
- Best

Power Saver	LCD power off time	Turn off time
Auto	3 min	5 min
Normal	1 min	3 min
Best	30 s	1 min

## Language

Refer to the “Reset your language” section on page 25.

## World Time

The World Time setting is a useful function for your overseas trips. This feature enables you to display the local time on the LCD while you are abroad.

1. Press the [ ▲ AF ]/[ ▼ ⏻ ] button to select the departure place ( 🏠 ) and destination ( 🌐 ) fields.
2. Press the [ ◀ 🌐 ]/[ ▶ ⚡ ] button to select a city located in the same time zone as that of the field. Press the ( SET ) button to confirm settings.



## Date & Time

Refer to the “Reset Date/Time” section on page 26.

## LCD Brightness

Use this setting to adjust the brightness of your LCD.

Press the [ ◀ 🌿 ]/[ ▶ ⚡ ] button to adjust the brightness of screen and press the ( SET ) button to confirm.

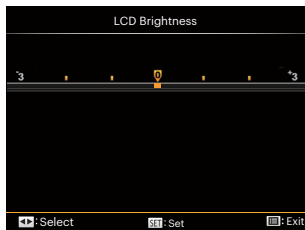

## File Settings

Mode: PSAM SCNCS



1. Press the button, press the [ ▲AF ]/[ ▼🗑️🕒 ] button to select .
2. Press the button to enter the menu.
3. Press the [ ◀️🌱 ]/[ ▶️⚡ ] button to select .  
5 options in [File Settings] :
  - Format
  - Copy to Card
  - File Numbering
  - Reset Settings
  - Version
4. Press the [ ▲AF ]/[ ▼🗑️🕒 ] button to select the item to be set and press the button to enter the menu.
5. Press the [ ▲AF ]/[ ▼🗑️🕒 ] button to select [Yes] or [No] and press the button to confirm.

Refer to the following pages for more details about each setting.

## Format

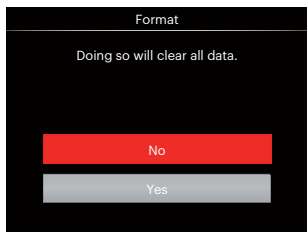
Please note: formatting enables you to delete all contents on the memory card and camera's built-in memory, including protected photo and movie files.



-  If you select [Yes] the camera will format its memory.
-  If there is no memory card in the camera, the built-in memory will be formatted; if there is a memory card, only the memory card will be formatted.



## Copy to Card

Use this setting to copy the files stored in the built-in memory to a memory card.

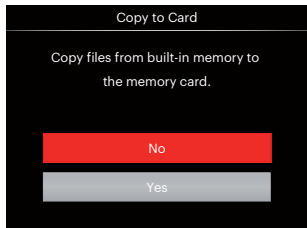

If there is no card available in the camera, this function will not be displayed.

## File Numbering

After you take a picture or video clip, the camera will save it with a sequential number. You can use this to reset the file numbering to 1.

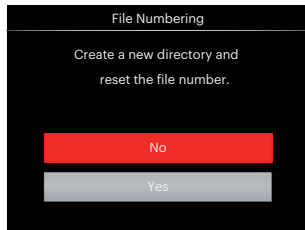

## Reset Settings

Use this setting to restore the camera to its original default settings.

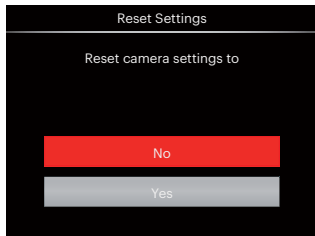

## Version

Use this setting to view the current camera firmware version.



When there is a new firmware version in the memory card, select [Yes] to update.

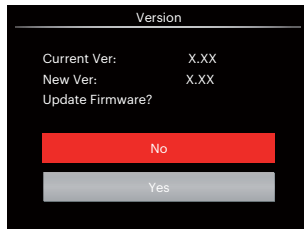















# CONNECTION SETTINGS

## Connecting to a Computer

You can use a Micro USB cable to connect the camera and copy (transmit) photos to a computer, printer or other device.

### Setting the USB Mode

The camera's Micro USB port can be used to connect to either a computer or a printer. The following steps will allow you to ensure that the camera is correctly configured to connect with a PC.

1. Press the  button, press the [ ▲ AF ]/[ ▼   ] button to select  and press the  button to enter the menu.
2. Press the [ ◀  ]/[ ▶  ] button to select .
3. Press the [ ▲ AF ]/[ ▼   ] button to select [USB] and press the  button to enter the menu.
4. Press the [ ▲ AF ]/[ ▼   ] button to select [PC] and press the  button to confirm.

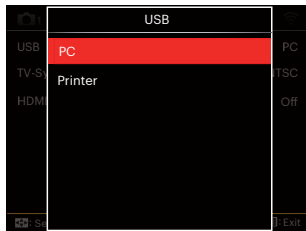

## Transferring Files to your Computer

The computer will automatically detect the camera as a removable drive. Double-click the “My Computer” icon on the desktop to locate the removable drive and to copy folders and files in the drive to a directory on your PC as you would copy any typical folder or file.

Follow the steps below to connect the camera to a computer:

1. Make sure the computer is turned on.
2. Connect one end of the supplied Micro USB cable to the Micro USB port on your camera.
3. Connect the other end of the cable to an available USB port on your computer.
4. After the transmission is complete, disconnect the Micro USB cable according to your computer manufacturer's instructions specifying how to safely remove USB devices.

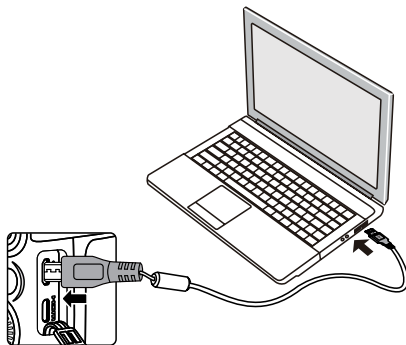















## Connecting to a PictBridge Compatible Printer

PictBridge technology allows printing on the photos saved in the memory card by a printer.



To find out if a printer is PictBridge compatible, simply look for the PictBridge logo on the packaging or check the owner's manual for specifications. With the PictBridge function on your camera, you can print the captured photos directly to a PictBridge compatible printer using the supplied Micro USB cable, without the need for a PC.

### Setting the USB Mode

The camera's Micro USB port can be set to connect with either a PC or a printer. The following steps will ensure that the camera is correctly configured to connect with a compatible printer.

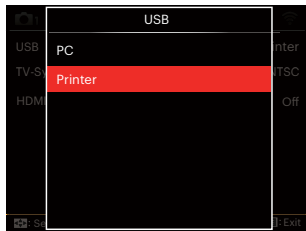
1. Press the  button, press the [ ▲ AF ]/[ ▼   ] button to select  and press the  button to enter the menu.
2. Press the [ ◀  ]/[ ▶  ] button to select .
3. Press the [ ▲ AF ]/[ ▼   ] button to select [USB] and press the  button to enter the menu.
4. Press the [ ▲ AF ]/[ ▼   ] button to select [Printer] and press the  button to confirm.



-  After the camera is reset, it will switch to PC mode automatically from USB mode.
-  See “Using the PictBridge Menu” section on page 112.

## Connecting to your Printer

1. Make sure the printer is turned on.
2. Connect one end of the supplied Micro USB cable to the Micro USB port on your camera.
3. Connect the other end of the cable to the USB port on the printer.

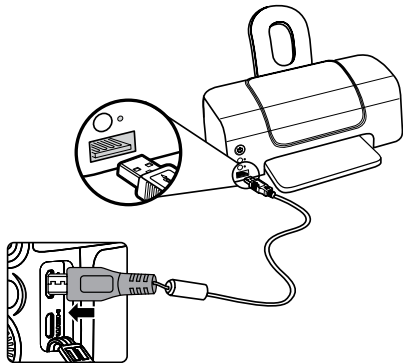

If the camera is not connected to a PictBridge compatible printer, the following error message will appear on the LCD.

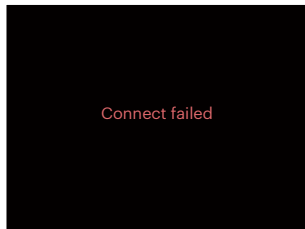

-  The error message above will also appear if the USB mode is set incorrectly, in which case you should disconnect the Micro USB cable, check the USB mode settings, ensure that the printer is turned on, and then try connecting the USB cable again.

## Using the PictBridge Menu

After setting the USB mode to printer, the PictBridge menu will appear.

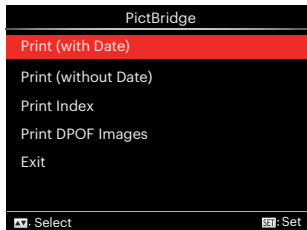

Press the [▲ AF]/[▼🗑️🌞] button to select a menu item and press the (SET) button to enter the item.

Refer to the following sections for more detailed information on each setting.

### Print (with Date)

If you have set the date and time on your camera, the date and time will be recorded and saved with each photo you take.

1. In the PictBridge menu, select [Print (with Date)] and the screen as shown below appears.



2. Press the [◀🌸]/[▶🔌] button to select a photo to be printed.

3. Press the [ ▲ AF ]/[ ▼ ☒ ☺ ] button to select the number of copies for the currently displayed photo.
4. Press the (SET) button and the following screen will appear.

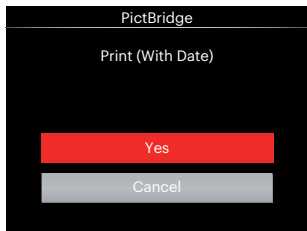

5. Select [Yes] and press the (SET) button to confirm; select [Cancel] to cancel printing.

## Print (without Date)

Use this setting to print the photos without dates on them.

1. In the PictBridge menu, select [Print (without Date)] and the screen as shown below appears.

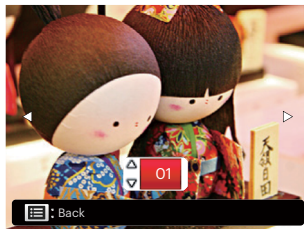

2. Press the [ ◀ ☒ ]/[ ▶ ⚡ ] button to select a photo to be printed.
3. Press the [ ▲ AF ]/[ ▼ ☒ ☺ ] button to select the number of copies for the currently displayed photo.
4. Press the (SET) button and the following screen will appear.



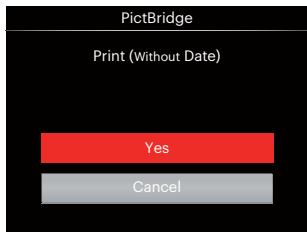

5. Select [Yes] and press the **SET** button to confirm; select [Cancel] to cancel printing.

## Print Index

You can print all photos in the camera via this function.

1. In the PictBridge menu, select [Print Index] and the screen as shown below appears.

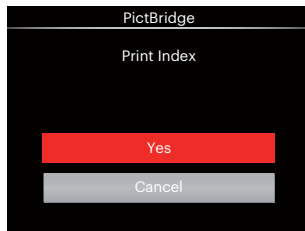

2. Select [Yes] and press the **SET** button to confirm; select [Cancel] to cancel printing.

## Print DPOF Images

To use DPOF printing, you must select your photos for printing using the DPOF settings before hand. See “DPOF” section on page 99.

1. In the PictBridge menu, select [Print DPOF Images] and the screen as shown below appears.

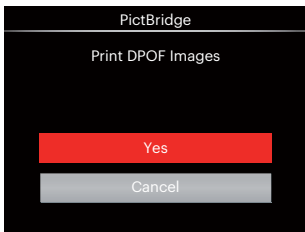

2. Select [Yes] and press the **(SET)** button to confirm; select [Cancel] to cancel printing.

## Exit



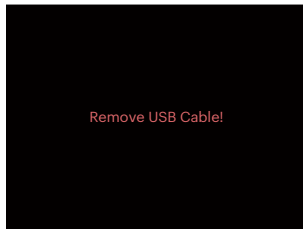



















Select [Exit] to exit the PictBridge menu. At this time, the message [Remove USB Cable!] will appear on the screen.



Disconnect the Micro USB cable from the camera and printer.

## Video System

You can use the AV cable (which should be purchased separately) to connect the camera and the television for setting up the video output. Connect one end of the AV cable to USB/AV port of the camera, and connect the other end to AV-OUT port of the television. To adjust the format of the video output system according to your requirements:

1. Press the  button, press the [  AF ]/[    ] button to select  and press the  button to enter the menu.
2. Press the [   ]/[   ] button to select .
3. Press the [  AF ]/[    ] button to select [TV-System] and press the  button to enter the menu.
4. Press the [  AF ]/[    ] button to select [NTSC] or [PAL] and press the  button to confirm.

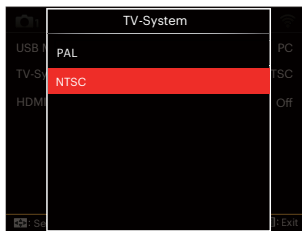

- NTSC: English, Chinese (Traditional), Japanese, Korean, Vietnamese
- PAL: German, Spanish, Italian, Chinese (Simplified), Portuguese, Swedish, Danish, Finnish, Indonesia, Norwegian, Dutch, Turkish, Polish, Thai, Croatian, Czech, Arabic, Hindi, French, Russian, Greek, Hungarian

## Supported HDMI Connections

HDMI (High Definition Multimedia Interface), is a fully digital audio/video transmission interface, through which uncompressed audio and video signals are transmitted.

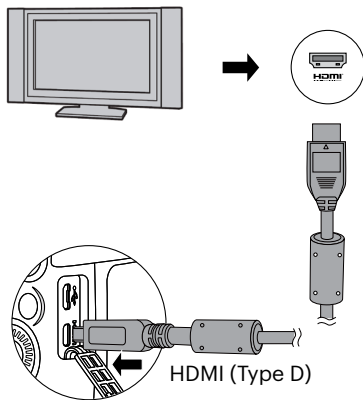

### Connecting HDMI-Ready TV



1. Use the cable with high resolution output terminal (which should be purchased separately) to connect the camera to the television which meets HDMI standards.
2. The camera will be automatically detected by the TV.
3. After connecting via HDMI, the camera enters Playback Mode.

 Make sure the camera and the TV are both turned on before connecting.













## HDMI CEC Control







After connecting the camera with TV-System, you may view pictures taken with the camera on the TV screen and operate the camera with your TV remote control to view and edit all images.



-  It is required that the TV-System supports HDMI CEC.
-  After the camera is successfully connected with TV-System, other buttons of the camera except the Power button cannot work, with the LCD staying dark.
-  Please refer to TV manual for relative settings of TV-System.

### Introduction on Icons

1.  Info Hiding/Display
2.  Zoom-in  
 : Zoom in Images  
 : Zoom out Images
3. Rotate Images  
 : Only Turn Left
4.  Image Index  
 : 5\*3 Index Playback  
 : 10\*5 Index Playback  
 : 3\*1 Date Folder Index  
 : 5\*3 Cont. Group Index
5.  Back
6.  Play Slide Show
7.  Button for Switching Between Previous and Next Images

8.  Videos
9. Movie Length:00:00:00
10.  Cont. Group File
11.  First Image Mark
12. 000/000:Current Sorting/Total Number of Images in Group
13.  :Confirm Effect  

14.  :No Change  

The following operations are available during HDMI CEC playback:

- 1:1 Single Playback
- Zoom-in Playback
- Rotate
- Index Playback
- Cont. Group Playback
- Slide Show Playback
- Video Play
- Panoramic File Play
- Image Edit

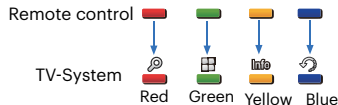
 Pressing the four-color button on remote control can enable relative functions displayed on the TV-System screen.



### 1:1 Single Playback:

Press the left and right arrow buttons to switch among images.

### Zoom-in Playback:





Under the 1:1 Single Playback Mode, press the red button to zoom in images; press the red and green buttons on remote control to zoom out images.

### Rotate:

Under the 1:1 Single Playback Mode, press the blue button to rotate single picture.

### Index Playback:

Under the 1:1 Playback Mode, press the green button to enter index playback; press the central button to enter image selection and then the arrow buttons to select files you want. Press the central button again to back to the 1:1 Single Playback.

Under the 5\*3 index playback mode, press the green button to enter index selection and then the left and right arrow buttons to select , , , and . Press the central button again to confirm your selection.

### Cont. Group Playback:

Under the 1:1 Single Playback Mode, press the central button to start playing images in Continuous Group.

If no images in the camera's Cont. Group, a prompt of no pictures will appear if you select  on the index playback interface.

### Slide Show Playback:

Under the 1:1 Single Playback Mode, press the down arrow button to enter Slide Show Playback. While playing, you may press the left and right arrow buttons to directly switch between previous and next images and the central button to end playing.

### Video Play:

Under the 1:1 Single Playback Mode, select a video and then press the central button to start playing. During playback, you may use the arrow buttons and the central button to perform operations such as fast forward/backward, pause, frame forward/backward, back to play, etc. according to prompts on the screen.

### Panoramic File Play:

Under the 1:1 Single Playback Mode, select a panoramic file and then press the central button to begin playing.

### Image Edit:

Multiple edit can be repeated under Image Edit Mode. Only one picture is saved finally.

Under the 1:1 Single Playback Mode, select a picture and then press the up arrow button to enter image edit and start detecting face.

Press the up arrow button to do HDR editing.

Press the down arrow button to delete one picture.

Press the left and right arrow buttons to edit the color. 12 effects in total for selection.

The following Beautifier Touch-Up functions cannot be enabled until a face is detected. You may press relative color buttons to edit.



: Skin Soften



: Eye Enlargement



: Eye Brightening

Availability of edit functions corresponding to each type of file (O : Available; X : Not available)

	HDR	Color	Beautifier	Delete
Normal (face)	O	O	O	O
Normal (no face)	O	O	X	O
Panorama	X	X	X	O
Video	X	X	X	O



## HDMI CEC Connection

Function	Full Size Playback	Zoom-in Playback	Index Playback	Video Play	Cont. Group Play	Panoramic File Play
Zoom In	○	○ (Movable to four directions during zoom-in)	X	X	X	X
Zoom Out	X	○	X	X	X	X
Rotate	○ (Turn left only)	X	X	X	X	X
Play Slide Show	○	X	X	○	○	○
Edit Image	○*1	X	X	○	○	○
Info Hiding/ Display	○	○	X	○*2	○*2	○*2
Delete	○	X	X	○*3	○*3	○*3



















\*1 Beautifier options will not appear until a face is detected.

\*2 Available before and in playing and during pause.

\*3 Deleting one file will not work until the camera enters image edit mode.

## Set Eye-Fi SD Card Connection Mode

This camera supports wireless connection for Eye-Fi memory cards. Enable the Eye-Fi connection by following the steps below.

1. Press the  button, press the [ ▲ AF ]/[ ▼    ] button to select  and press the  button to enter the menu.
2. Press the [ ◀   ]/[ ▶   ] button to select .
3. Press the [ ▲ AF ]/[ ▼    ] button to select [Eye-Fi] and press the  button to enter the menu.
4. Press the [ ▲ AF ]/[ ▼    ] button to select [On] or [Off] and press the  button to confirm.



If the Eye-Fi card is not available in the camera, this feature is not displayed.

# APPENDICES

## Product Specifications



Design and specifications are subject to change without notice.

Image Sensor	Type	1/2.3" BSI CMOS
	Effective Pixels	20.68 Megapixels
	Total Pixels	21.14 Megapixels
Lens	Focal Length	4.3 mm (Wide) — 279.5 mm (Tele)
	35 mm Film Equivalent	24 mm (Wide) — 1560 mm (Tele)
	F number	F2.9 (Wide) — F6.7 (Tele)
	Lens Construction	14 groups 18 elements
	Optical Zoom	65x
	Focusing Range	Normal: (Wide) 50 cm ~ $\infty$ , (Tele) 250 cm ~ $\infty$ ; Macro: 1 cm ~ $\infty$ (Wide Only)
Autofocus System		TTL Autofocus
Electronic Viewfinder		Yes (-3 ~ +1 diopter)
Anti-Handshake		Optical Image Stabilization
Digital Zoom		4x Digital Zoom (Combined Zoom: 260x)

Number of Recording Pixels	Still Image	(4:3) 20MP: 5184 × 3888 10MP: 3648 × 2736 5MP: 2592 × 1944 3MP: 2048 × 1536 0.3MP: 640 × 480	(3:2) 18MP: 5184 × 3456	(16:9) 15MP: 5120 × 2880 2MP: 1920 × 1080
	Movie	1920 × 1080 (30fps), 1280 × 720 (60fps), 1280 × 720 (30fps), 640 × 480 (30fps), High-Speed Movie: 640 × 360 (120fps)		
Image Compression		Best, Fine		
DCF, DPOF (Ver1.1) Support		Yes		
File Format	Still Image	JPEG (Fine, Standard), RAW, RAW+ JPEG (Fine)		
	Movie	MOV [Image: H.264; Audio: Linear PCM (Stereo)]		
Shooting Modes		Auto Mode, Program AE, Shutter priority, Aperture priority, Manual Mode, Face Beautifier, Wi-Fi® Mode, Scene Mode, Movie Mode, Custom Settings		
Scene Mode		Auto Scene, Panorama Mode, Handheld Night, Multi Exposure, Cat/Dog, Snow, Party, Sport, Night Portrait, Portrait, Children, Landscape, Sunset, Fireworks		
Detection Features		Face, Smile, Blink, Cat, Dog		
Photo Touch-Up		Red-Eye Reduction, Skin Soften, Eye Brightening, Eye Enlargement		

HDR		Yes
Scan Panorama		Up to 360°
LCD	Display	3.0 inch (920k Pixels)
	Angle Adjustment	Yes
Image Auto Rotation		Yes
ISO Sensitivity		Auto, ISO100/200/400/800/1600/3200
Focus Mode		Single AF, Continuous AF, Object Tracking, Manual Focus
Focusing Area Selection		Single Area Focusing, 25-Area-Focusing, Face Detection, Manual Area Focusing
Exposure Metering Method		Artificial Intelligence AE (AiAE), Center-Weighted Average, Spot (Fixed to Center of Frame), Face AE
Exposure Control Method		Program AE (AE-Lock Available), Shutter Prior AE, Aperture Prior AE
Exposure Compensation		± 3 EV in 1/3 Step Increments
Shutter Speed		1/2000 ~ 30 Seconds
Continuous Shooting		Yes
Playback Modes		Single, Index (9/16 Thumbnails), Slide Show, Date, Burst Shooting, Zoom (Approx. x2 ~ x8)

White Balance Control		AWB, Daylight, Cloudy, Fluorescent, Fluorescent H, Incandescent, Manual WB, Color Temp. (1900K ~ 10000K)
Flash	Flash Method	Pop-up (Auto)
	Flash Modes	Force Off, Fill Flash, Flash Auto, Red-Eye Reduction, Slow Sync., Slow Sync. + Red-Eye Reduction
Recording Media		Internal Memory: Approx. 15MB
		SD/SDHC Card (Up to 32GB Support) [MMC Card Not Supported]
Multi-Language Support		27 Languages
Jacks		AV-OUT/USB 2.0 (Micro 5 pin USB), HDMI (Type D)
Eye-Fi Support		Yes
Wi-Fi®		Yes (802.11 b/g/n)
Remote Viewfinder		Yes (via iOS/ANDROID smart device)
Power		Rechargeable Li-ion Battery LB-070, 7.4V 1020mAh, In-Camera Charging
Shooting Capability (Battery Performance)		Approx. 400 Shots (Based on CIPA Standards)
Operation Environment		Temperature: 0 ~ 40°C, Humidity: 0 ~ 90%
Dimensions (W × H × D)		Approx. 125.9 × 89.0 × 113.6 mm (Based on CIPA Standards)
Weight		Approx. 602g (Body only)

## Prompts and Warning Messages

Message	Description	Action
Warning! Battery exhausted.	Camera battery is depleted. It is a warning indicating the camera is going to shut off.	Charge battery or replace with a charged battery.
Built-in memory error!	An error has occurred in the built-in memory.	Try shutting the camera off and turning it on again.
Warning! Do not turn off your camera during update!	The message appears during the firmware update process.	The message disappears after the camera update and restart.
Battery temperature is too high.	Battery has reached a temperature that is not ideal for operation.	The message will disappear after 2 seconds. Let the battery cool before attempting to use the camera again.
Please update firmware after the battery is fully charged!	The firmware cannot be updated when power is insufficient.	Charge the battery fully before reattempting to update firmware.

Message	Description	Action
Cannot change settings under this mode.	Appears during shooting mode if a function can not be set by rotating the function ring.	Choose a different mode in order to change settings.
Improper alignment. Please try again.	The offset is too big for panorama shooting.	Remove the message after 2 seconds and return to shooting.
Connection Failed!	Failure to connect to PC, Printer, or TV-system.	Remove cable, reinsert cable, and retry connection
In this capture ***** Still size limited to ** M	After choosing the image size in the Function Ring (Smart), this message may occur when the still size limit is reached.	Remove the message after 2 seconds and return to shooting.
Capture reached maximum limit	Press the shutter to capture images in recording a video. If the number of images captured exceeds 15, there will be a prompt if you press the shutter again.	The message will disappear in 2 seconds with no influence to video recording.



Message	Description	Action
Write Protect !	The memory card is locked.	Turn off camera and remove SD card. Slide tab on the side of card to unlock.
Card Full !	The memory of the SD card is full.	Either delete photos or videos to create room on the card, or replace with another card that has available memory.
Memory Full !	The camera's internal memory is full.	Erase files or insert a memory card that has available memory.
Exceeded maximum folder number.	The folder number in the card exceeds the maximum folder number (999).	Copy the data to your PC, and format the memory card.
Card Error !	The card cannot be recognized after being formatted.	Check that the SD card is compatible with the camera.
Card is not formatted.	An error has occurred with the memory card.	Format the memory card. This will erase all data on the card; be sure to copy the data from the card onto another device if you wish to keep it.

Message	Description	Action
Slow access	When a card lower than Class 4 is recording movie above HD, it may be accessed slowly and the recording will not be continued.	Replace SD card with a Class 4 or higher card.
Cannot write to SD card.	The camera cannot write to the SD card.	Turn off the camera. Remove and reinsert the SD card and turn the camera on to try again. Check if the SD card is in a locked position, or if the memory is full.
No Picture!	When the play button is pushed and there are no files on memory card or in camera.	The message will disappear after 2 seconds and return to previous screen.
No continuous group file.	When the camera switches from Playback Mode to Cont. Playback Mode, and there are no continuous group files, this message will be displayed.	The message will disappear after 2 seconds and return to Thumbnail 3x3 mode.
No Red-Eye Detected!	No red-eye is detected when selecting Red-Eye Removal in Playback Touch-up.	The message will disappear after 2 seconds and return to the touch-up menu.

Message	Description	Action
Too many pictures for fast processing.	During Playback by Date, the images exceed specifications so it is not possible to play by date.	The message will disappear after 2 seconds and return to Thumbnail 3x3 mode.
Unable to recognize files.	The format of the file viewed is not supported or the file is damaged and cannot be recognized properly.	This message will only disappear after the file is deleted.
Protected! Undeletable!	The file is protected and cannot be deleted.	Unlocked file under "Protect", and make sure SD card is unlocked.
This image cannot be edited.	The file format does not support editing or the edited file cannot be edited again.	The message will disappear after 2 seconds and return to the original image.
Cannot edit because no face detected!	A face cannot be detected in the image in the touch-up menu.	The message will disappear after 2 seconds and return to the touch-up menu.
Suggest using tripod.	When continuous exposure mode (Sunset, Multi Exposure, Fireworks, Night Portrait) is enabled, this prompt message is displayed when the photo shooting screen is displayed for the first time.	This message will disappear after 2 seconds.

## Troubleshooting

Problem	Possible causes	Solution
Camera does not turn on	<ul style="list-style-type: none"><li>■ The battery has been depleted.</li><li>■ The battery is not inserted correctly.</li></ul>	<ul style="list-style-type: none"><li>■ Replace the battery.</li><li>■ Correctly reinstall the batteries.</li></ul>
Camera turns off suddenly during operation	<ul style="list-style-type: none"><li>■ The batteries have been depleted.</li></ul>	<ul style="list-style-type: none"><li>■ Replace the battery.</li><li>■ Make sure the camera is actually shutting off and not entering Power Save Mode, where the LCD will turn off after the camera has been idle for a period of time.</li></ul>
The picture is blurry	<ul style="list-style-type: none"><li>■ Camera shakes while taking a picture.</li></ul>	<ul style="list-style-type: none"><li>■ Turn on OIS Feature.</li><li>■ Please use tripod for high magnification (above 15X) optical zoom. If you are holding the camera, be sure to use both hands.</li></ul>
Images and video files cannot be saved	<ul style="list-style-type: none"><li>■ The memory card is full.</li><li>■ The memory card is locked.</li></ul>	<ul style="list-style-type: none"><li>■ Use another memory card or delete unnecessary files.</li><li>■ Unlock the memory card.</li></ul>

Problem	Possible Causes	Solution
Images will not print from the connected printer	<ul style="list-style-type: none"> <li>■ The camera is not connected to the printer correctly.</li> <li>■ The printer is not PictBridge compatible.</li> <li>■ The printer is out of paper or ink.</li> <li>■ The printer paper is jammed.</li> </ul>	<ul style="list-style-type: none"> <li>■ Check the connection between the camera and printer.</li> <li>■ Use a PictBridge compatible printer.</li> <li>■ Load paper into the printer or replace the ink cartridge in the printer.</li> <li>■ Remove the jammed paper.</li> </ul>
Saving data to memory card is slow	<ul style="list-style-type: none"> <li>■ Using a memory card below Class 4 may result in slower recording times.</li> </ul>	<ul style="list-style-type: none"> <li>■ Use a memory card with write Class 4 or higher to improve performance.</li> </ul>
Cannot write to the memory card	<ul style="list-style-type: none"> <li>■ The memory card has been locked.</li> </ul>	<ul style="list-style-type: none"> <li>■ Release the write lock of the memory card or replace with another card.</li> </ul>
Too many movies to process	<ul style="list-style-type: none"> <li>■ The number of pictures or folders in the memory card exceed the specifications, so the playback of data folder can not be displayed.</li> </ul>	<ul style="list-style-type: none"> <li>■ Delete unwanted files.</li> </ul>

When shooting with stacked filters attached, the corners of the photo may turn dark (vignetting effect) because the filter holder blocks light from reaching the camera image sensor; especially, at wide angle zoom control settings. Please take test shots and review the results when using stacked filters. (Filter size :  $\Phi 52\text{mm}$ )

If you choose to change the factory assigned, random Wi-Fi® password on your AZ652 camera, please be sure to update and enter the new randomly assigned password on your smart device. Some smart devices will automatically remember and save any previously entered Wi-Fi® password. Be sure to clear the old password on your smart device manually before attempting to connect to the AZ652's Wi-Fi® to your device. (Depending upon your smart device make and model, operation may vary, so please refer to your smart device user manual and instructions.”

### iOS™ Example

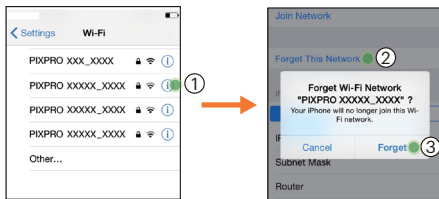

### Android™ Example

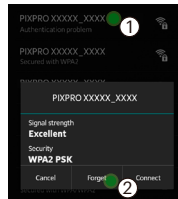

## HDR- High Dynamic Range

HDR captures three photos taken at different exposure levels and combines them into one photo. This optimizes all the details of the object or scene in the photo. Even the features in darker areas can be viewed clearly. (The following pictures are an example of HDR composition.)

Underexposed



Normal exposure



Overexposed



HDR Mode

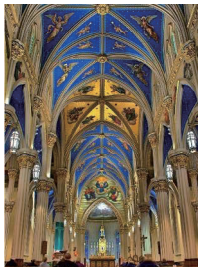

## **WDR- Wide Dynamic Range**

For high light, intense sunlight, or environments with artificial light, WDR allows PIXPRO's smart algorithm to correct shadows surrounding a subject. This makes it easier to distinguish details in darker areas of the photo.

With WDR enabled video, clear images are provided when there are not only very bright areas, but also very dark areas in the camera's field of view. (The following pictures are an example of WDR.)

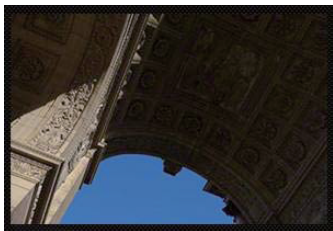

Without WDR

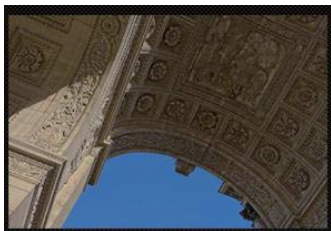

With WDR



## Memory Card Compatibility

Refer to the chart below for compatible types of SD cards (✓ : Compatible X: Not Compatible)

	micro SD	micro SDHC	micro SDXC	Conversion adapter to SD card	SD	SDHC	SDXC
Format	FAT12, 16	FAT32	exFAT	-	FAT12, 16	FAT32	exFAT
Capacity	Up to 2GB	4-32GB	64GB-2TB	-	Up to 2GB	4-32GB	64GB-2TB
Compatibility	X	X	X	✓	✓	✓	X

It indicates that the writing speed class will be displayed on the memory card. Use a memory card with the appropriate writing speed for the video recording mode to be recorded. (O: Recommended X: Not recommended)

	Speed Class	UHS Speed Class	Video Speed Class	Video Recording			
				4K	FHD	HD	VGA
90MB/sec			V90	O	O	O	O
60MB/sec		UHS-III	V60	O	O	O	O
30MB/sec		UHS-I	V30	O	O	O	O
10MB/sec	Class 10		V10	O	O	O	O
6MB/sec	Class 6		V6	X	O	O	O
4MB/sec	Class 4			X	X	X	O
2MB/sec	Class 2			X	X	X	O

© 2023 JK Imaging Ltd. All Rights Reserved.

The Kodak and Kodachrome, Kodacolor and Ektachrome trademarks, logo and trade dress are used under license from Eastman Kodak Company.

All other logos, products or company names that are referred to in this document are trade names, trademarks or registered trademarks of their respective owners and holders. The owners and holders are not affiliated with JK Imaging Ltd., our products or our website.

JK Imaging Ltd., 17239 So. Main Street, Gardena, CA 90248 USA

[kodakpixpro.com](http://kodakpixpro.com)

Made in Myanmar (Burma)

Document No/Sequence: U.DIS.0062.0323.en.10



Ver. 10.0